

# Metering Pumps



## EWN-R Series Electromagnetic Metering Pumps

The EWN-R Series electronic metering pumps offer superior high speed dosing capability with more standard features. The flexibility of the EWN-R pump enable it be integrated into virtually any chemical feed application using a universal-voltage, digital controller with an expanded set of control features. Superb valve performance and advanced solenoid engineering combine to make a highly precise pump for the most demanding applications.

EWN pumps have outputs to 6.7 GPH (25.2 L/h) and a maximum pressure of 250 PSI (17 bar). The high speed of operation results in high resolution chemical feed and long service life. Quiet and compact, the EWN pump prime in seconds and hold prime reliably.



### ➤ High Speed Performance

E-Series pumps operate up to 360 strokes-per-minute with adjustments in 1 spm increments, providing high resolution chemical feed. Adjustable stroke length further increases the ability to refine output, making the E-Series one of the most versatile solenoid metering pumps on the market.

### ➤ Multi-function Digital Controller

The controller in the EWN-R pump provides for flexible pump control including scalable Analog control, Digital Input with both Multiply and Divide capability, external stop control, or simple speed and stroke length control. Display of can be adjusted between flow rate units or %speed for easy-to-read output and enables quick adjustment. The controller is universal voltage so it can be used anywhere in the world.

### ➤ Engineered Longevity

All E-Series pumps feature dual bearing support. The armature and shaft are supported with a bearing on each end, which ensures proper axial movement, enabling the E-Series to operate at 360 SPM while extending the life of the diaphragm.

### ➤ Superior Check Valve Performance

Dual Check Valve Assemblies in both suction and discharge fittings feature precision ball guides and tapered seats. Precise machining and molding of parts limit valve ball travel, ensuring that balls fully seat and seal with every stroke. This superior check valve design guarantees fast priming and reliable performance.

### ➤ Flexible Connections

A removable tubing insert provides flexibility of tubing sizes and eliminates twisting of the tubing during connection. A threaded insert can be used in place of the tubing adapter to easily convert any connection to NPT.



### ➤ High Compression Ratio

The compression ratio of a metering pump is important because it affects the pump's ability to prime and vent. The compression ratio is raised when you reduce the dead volume of the pump head during operation. All E-Series pumps feature a very high compression ratio that ensures proper feed especially with off-gassing products (i.e. Sodium Hypochlorite).

**W A L C H E M**

IWAKI America Inc.

# Specifications

## Model Identification

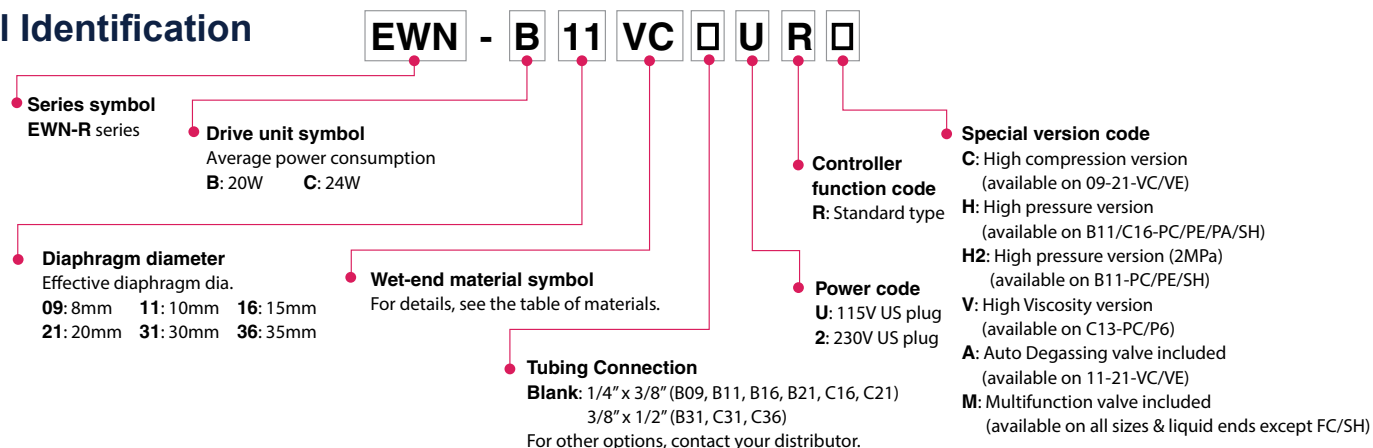

## Wet End Materials

	Pump Head	Diaphragm	Valve Balls	Valve Seat	O-ring Seal	Gasket
VC	PVC	PTFE +EPDM	CE	FKM	FKM	PTFE
VE				EPDM	EPDM	
VF				EPDM	EPDM	
PC	GFRPP		CE	FKM	FKM	
PE				EPDM	EPDM	
PA				PCTFE	AFLAS®	
FC	PVDF			PCTFE	PTFE	
TC				FKM	FKM	
TA				PCTFE	AFLAS®	
SH	SUS316	HC	SUS316	PTFE		

CE	Alumina ceramic	EPDM	Ethylene propylene diene monomer
FKM	Fluoroelastomer	GFRPP	Glass fiber reinforced polypropylene
PTFE	Polytetrafluoroethylene	PVC	Polyvinylchloride (translucent)
PCTFE	Polychlorotrifluoroethylene	HC	Hastelloy C276
PVDF	Polyvinylidene fluoride		

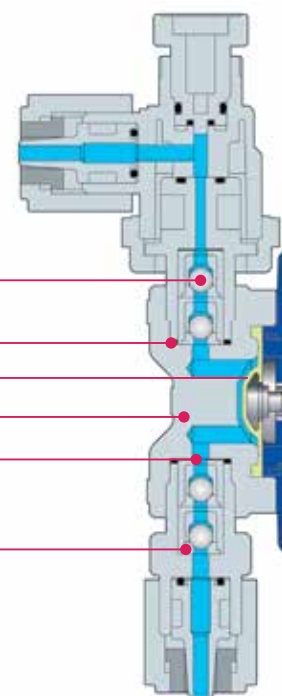

## Pump Specifications

Model		B11	B16	B21	B31	C16	C21	C31	C36	
									VC/VE/PC/PE	FC/SH/TC
Max. Output Capacity	GPH	0.6	1.0	1.6	3.2	1.3	2.1	4.3	6.7	6.5
	mL/min	38	65	100	200	80	130	270	420	410
	mL/shot	0.02-0.1	0.04-0.18	0.06-0.28	0.11-0.56	0.04-0.22	0.07-0.36	0.15-0.75	0.23-1.17	0.23-1.14
Rated discharge pressure	PSI	145	102	58	29	1.0	0.7	0.35	0.2	0.2
Max pressure	PSI	203	116	73	30	1.2	0.8	---	---	---
Stroke rate	% (spm)	0.1 to 100 (1 to 360)								
Stroke length rate	% (mm)	20 to 100 (0.2 to 1.0)				20 to 100 (0.25 to 1.25)				

Note 1: Max. output capacity shown is at rated discharge pressure (stroke length 100%, stroke rate 100%) and increases as a discharge pressure reduces.

Note 2: The performance is based on pumping clean water at ambient temperature at rated discharge pressure and voltage.

Note 3: Liquid temperature -VC/VH types: 14 to 104°F (-10 to 40°C) -PC/PH/FC/SH/TC types: 14 to 140°F (-10 to 60°C)

Note 4: Max pressure of PVC type is 174 PSI. Please contact your distributor for more information.

# Specifications

## Controller Specifications

Operational mode	MAN	0.1 to 100% stroke rate	
	EXT control	DIV (Dividing)	/1 to 0000
		MULT (Multiply)	x1 to 9999
		ANA. R (Analog, rigid)	4 to 20, 0 to 20, 20 to 4, 20 to 0 mA
	ANA. V (Analog, variable)	2 points 0.0 to 20.0 mA range 0.0 to 100% stroke rate	
Display	LCD	14 segment 5 digits	% , ml/m, L/H, GPH, STOP, PRIME, AUX etc
	LED	ON	Green Green lights when ON blinks OFF synchronous with stroke.
		STOP	Orange/Red Orange lights when Pre-STOP is made, red when STOP is made.
Keypad	5 keys	START/STOP, EXT, ▲(UP), ▼(DOWN), Disp	
Control function	STOP/Pre-STOP	Pump keeps running when Pre-STOP is made. Pump stops when STOP is made.	
	Prime	Pump runs at max. stroke rate while up and down keys are pressed.	
	Key lock	Keypad can be locked and unlocked.	
	Calibration	Discharge capacity per shot is calculated automatically by operating and stopping pump in the calibration mode to determine the flow rate.	
	Buffer memory	ON or OFF selectable. Max. 65535 stroke pulses are stored in memory.	
Input	Pulse	No voltage contact or open collector. Max 200 Hz. NO/NC selectable	
	Current	DC0 - 20mA (Input resistance 200 Ω)	
	Stop/Pre-stop	No Voltage contact or open collector	
	AUX	Pump runs at max.stroke rate when made. No Voltage contact or open collector	
Output	Photo-MOS relay AC/DC24V 0.1A		
	STOP, Synchronous with stroke		

**Note 1:** If the max. stroke rate by calculation exceeds 100% stroke rate because of the relation between the setting and input signal when the pump is in EXT operation, the operation is fixed at Maximum stroke rate speed of manual operation.

**Note 2:** By changing the setting, the pump can run when the contact signal comes in. **Note 3:** The max. frequency of input pulse is 200 Hz. ON time of input pulse is 10 to 100 mS.

**Note 4:** The max. potential voltage at a contact is 12V and current is 0.1mA. If a contact such as relay is used, the minimum application load should be 0.1mA or less.

## Safety Certifications

The EWN series metering pumps\* are WQA tested and certified to NSF/ANSI Standard 50 and Standard 61.

\* See [www.wqa.org](http://www.wqa.org) for specific chemicals and certification parameters.



The EWN series metering pumps are tested by Intertek to UL and CSA standards.



## Electrical Specifications

EWN	EWN-B	EWN-C
50/60 Hz, 1 phase	20 Watt avg.	24 Watt avg.
100-240VAC ±10%	0.8 Amp max.	1.2 Amp max.

## Shipping weight

EWN-B: 10 lbs (4.5 kg)

EWN-C: 12 lbs (5.5 kg)

## Dimensions (in inches)

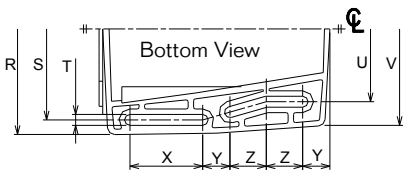
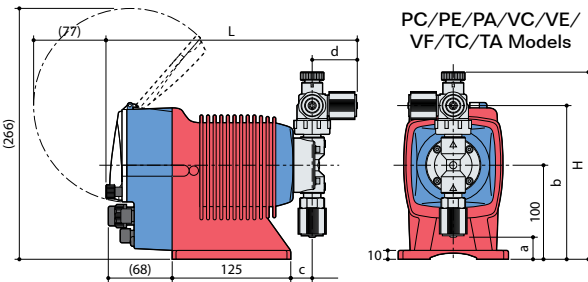

Material	Model	H	L	a	b	c	d
PC/PE/PA VC/VE/VF TC/TA	EWN-11,16, 21	7.83	10.43	0.94	6.45	0.90	1.85
	EWN-31	8.34	10.51	0.23	6.97	0.98	1.89
	EWN-36	8.30	10.51	0.27	6.93	0.94	1.89
SH	EWN-11,16, 21	7.91	9.13	1.73	6.10	0.86	0.59
	EWN-31	8.38	9.17	1.34	6.49	0.90	0.59
	EWN-36	8.50	9.17	1.26	6.69	0.90	0.59
FC	EWN-11,16, 21	6.53	9.09	1.57	6.31	0.90	0.51
	EWN-31	6.97	9.29	0.90	6.97	0.98	0.63
	EWN-36	6.97	9.25	0.90	6.97	0.94	0.63

## Mounting Dimensions

EW Model	R	S	T	U	V	X	Y	Z
11,16, 21	4.57"	3.94"	0.24"	3.15"	4.17"	1.57"	0.59"	0.79"
31, 36								

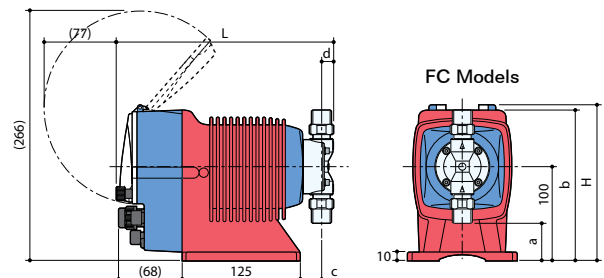
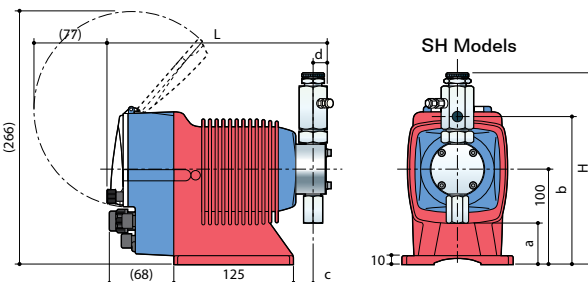

# Construction

## Auto Degassing Valve Model

Chemicals that outgas, such as Sodium Hypochlorite or Hydrogen Peroxide, can generate enough gas to gas lock metering pumps. Using a dual check valve system, the Auto Degassing Valve vents any gas to atmosphere to eliminate gas lock conditions and keep the pump primed.

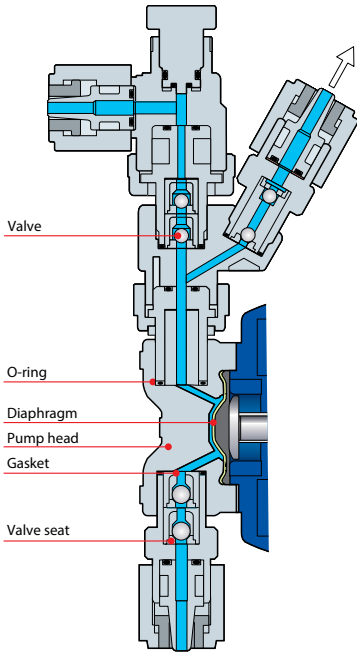

## High Compression Model

Increasing the compression ratio by minimizing dead volume in the liquid end further helps to eliminate gas in the pump heads. In addition to reducing air lock conditions, the increased compression ratio helps with accuracy at low output ranges.

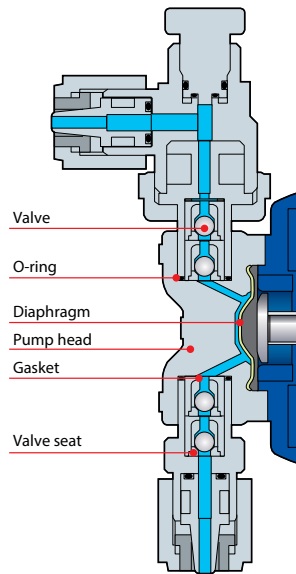

## High Pressure Model

The high pressure model is capable of operating at flow rates of 0.4 or 0.6GPH (25 or 40mL/min) at a maximum discharge pressure up to 250PSI. This makes it suitable for applications such as chemical injection into boiler make-up water.

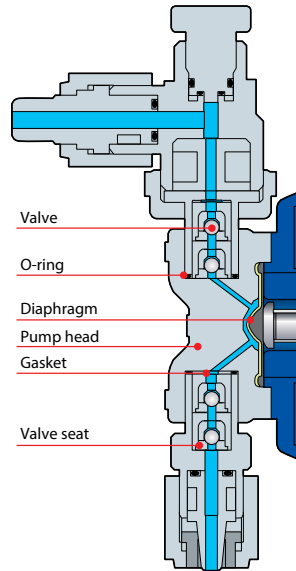

## High Viscosity Model

The High Viscosity pump has a uniquely designed liquid end with oversized flow paths and spring loaded valve checks. Coupled with a reduced max speed, the HV pumps are designed for polymer/coagulant injection in water treatment applications.

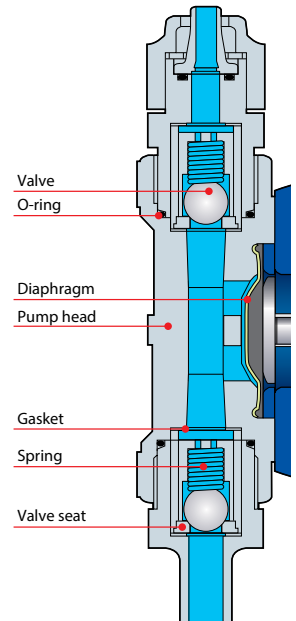

### Wet-end material

Material code	VC	VE
Pump head	PVC	
Valve	CE	
Valve seat	FKM	EPDM
Gasket	PTFE	
O-ring	FKM	EPDM
Diaphragm	PTFE+EPDM	

### Wet-end material

Material code	VC	VE
Pump head	PVC	
Valve	CE	
Valve seat	FKM	EPDM
Gasket	PTFE	
O-ring	FKM	EPDM
Diaphragm	PTFE+EPDM	

### Wet-end material

Material code	PC	PE	SH
Pump head	GFRPP	SUS316	
Valve	CE		
Valve seat	FKM	EPDM	SUS316
Gasket	PTFE		
O-ring	FKM	EPDM	—
Diaphragm	PTFE+EPDM		

### Wet-end material

Material code	PC	P6
Pump head	GFRPP	
Valve	CE	316 SS
Valve seat	PCTFE	
Spring	Hastelloy C276	316 SS
Gasket	PTFE	
O-ring	FKM	EPDM
Diaphragm	PTFE+EPDM	

### Specifications

Model	Auto Degassing Valve						High Compression Models						
	B11	B16	B21	C16	C21	B09	B11	B16	B21	C16	C21		
Capacity	GPH	0.5	0.9	1.4	1.0	1.7	0.2	0.4	0.6	1.0	0.9	1.2	
	mL/min	30	55	86	65	110	12	23	40	63	54	78	
	mL/shot	0.04 - 0.08	0.08 - 0.15	0.12 - 0.24	0.07 - 0.18	0.12 - 0.31	0.01 - 0.07	0.03 - 0.13	0.04 - 0.22	0.07 - 0.35	0.06 - 0.30	0.09 - 0.43	
Discharge pressure	PSI	150	105	60	150	105	150	150	105	60	150	105	
Stroke rate	% (spm)	0.1 - 100 (1-360)						0.1 - 100 (1-180)					
Stroke length range	% (mm)	20 - 100 (0.2 - 1.0)			20 - 100 (0.25 - 1.25)			20 - 100 (0.25 - 1.25)			20 - 100 (0.3 - 1.50)		

Model	High Pressure Models		High Pressure Models (300 psi)		High Viscosity Models	
	B11	C16	B11	C31		
Capacity	GPH	0.4	0.6	0.3	2.4	
	mL/min	25	40	17	150	
	mL/shot	0.02 - 0.1	0.03 - 0.17	0.05 - 0.07	0.13 - 0.63	
Discharge pressure	PSI	250	250	290	73	
Stroke rate	% (spm)	0.1 - 100 (1-240)		0.1 - 100 (1-240)		
Stroke length range	% (mm)	20 - 100 (0.2 - 1.0)	20 - 100 (0.25 - 1.25)	70 - 100 (0.5 - 0.9)	20 - 100 (0.25 - 1.25)	

Note 1: Each discharge capacity shown above is at discharge pressure (stroke length 100%, stroke rate 100%) and increases as a discharge pressure reduces.  
 Note 2: The performance is based on pumping clean water at ambient temperature at rated voltage.