

**UDC 100 & 150
STYLE DRYERS
WITH
FN CONTROLS**



ProTec



***System Engineering Worldwide
Universal Dynamics, Inc.
A Company of MANN+HUMMEL ProTec
13600 Dabney Road
Woodbridge, VA 22191
703.491.2191.phone 703.490.7001.FAX***

UNIVERSAL DYNAMICS INC.

A Company of the MANN+HUMMEL Group

Title: Spare Parts - UDC-100 Dryers, 230V/460V

CMM- 04/05/04

Dryer Parts

	UDC Part#	Part Name		
24 Pounds	16346	Cooling Fans		
	31144	Desiccant Screens		
	73026	Desiccant, 13X, 8x12 bead, Total 12 lbs.		
	48138	Door Hinges		
	75249	Filter Cover Gasket with Cooling Coil Only		
	71451	Filter Cover Hand Knob		
	31084	Filter Element (7.93"x10.0")		
	907075	Hose Kit, Internal		
	95137	Insulation Kit for Top Lid		
	95139	Insulation Kit for Bottom Lid		
	913254	Lower Insulation Repair Kit		
	08554	Pressure Switch (Gray)		
	*28179	Rotron Blower Motor		
	95203	<i>** If replacing mtr on dryers prior to 1997 use this retrofit number.</i>		
	31144	Screen for Desiccant Beds, 12.75", 20 Mesh		
	75026	Silicone Valve Seals		
	08566	Snap Switch (For Fans)		
	913255	Upper Insulation Repair Kit		
95179	Valve Assembly (Complete)			
95174	Valve Motor, Linear actuator *Requires model number*			

Controller Parts

	UDC Part#	Part Name		
	10544	Actuator for Disconnect Switch		
	08900	Contactor, A/B #100-C09D10		
	13702	Fiber Optic Cable		
	84386	FN Display Card		
	80356	FN Touchpad		
	84358	FN-X Main Card		
	84372	FN-X2 Output Card		
	09017	Fuse, 2.5 Amp, 250V, FNM		
	08032	Mercury Contactor 35Amp		
	19427	NVR Ram Chip(Memory Chip)		
	19316	On/Off Rocker Switch, 1 Pole, 10A		
	19483-R	Power Supply, 18 Watt		
	11292	Thermocouple (Return & Process)		

UNIVERSAL DYNAMICS INC.

A Company of the MANN+HUMMEL Group

Title: Spare Parts - UDC-100 Dryers, 230V/460V

CMM- 04/05/04

230V Components

230V	UDC Part#	Part Name		
	03435	Afthtr/Process Htr, Ogden #A5W-1209R		
	03576	Bedhtr/Regen Htr, Ogden #A6W-2194R		
	10540	Disconnect Switch, 63 Amp		
	07163	Overload Relay 3.7 - 12Amp		
	08636	Transformer 230 Volt		

460V Components

460V	UDC Part#	Part Name		
	03436	Afthtr/Process Htr, Ogden #A5W-1522R		
	03584	Bedhtr/Regen Htr, Ogden #A6W-2091R		
	10546	Disconnect Switch, 32 Amp		
	07162	Overload Relay, 1.6 - 5.0Amp		
	93000	Transformer 460 Volt		

Dewpoint Spare Parts

	UDC Part#	Part Name		
	19485	Dewpoint Sensor		
	HAR07-3	Dewpoint Cable		
	06031	Gasket f/Sensor		
	06033	Hex Nut		
	06026	Screen f/Sensor		
	11307	Sensor Housing		

*Note: Prices are subject to change without notice.

*Lead times that are provided are based on availability. Some lead times may vary.

Please contact the parts department for any further questions or information. You may fax your order direct to us for processing, we will provide a confirmation of your faxed order, if requested.

Direct Phone: 703-490-7009

Direct Fax: 703-490-7008

Email: customer.support@unadyn.com

UNIVERSAL DYNAMICS INC.

A Company of the MANN+HUMMEL Group

Title: Spare Parts - UDC-150 Dryers, 230V/460V

CMM- 04/05/04

Dryer Parts

24 Pounds

UDC Part#	Part Name		
16346	Cooling Fans		
31144	Desiccant Screens		
73026	Desiccant, 13X, 8x12 bead, Total 12 lbs.		
48138	Door Hinges		
75249	Filter Cover Gasket with Cooling Coil Only		
71451	Filter Cover Hand Knob		
31084	Filter Element (7.93"x10.0")		
907075	Hose Kit, Internal		
95137	Insulation Kit for Top Lid		
95139	Insulation Kit for Bottom Lid		
913254	Lower Insulation Repair Kit		
08554	Pressure Switch (Gray)		
*28178	Rotron Blower Motor		
95201	<i>** If replacing mtr on dryers prior to 1997 use this retrofit number.</i>		
75026	Silicone Valve Seals		
08566	Snap Switch (For Fans)		
11292	Thermocouple (Return & Process)		
913255	Upper Insulation Repair Kit		
95179	Valve Assembly (Complete)		
95174	Valve Motor, Linear actuator *Requires model number*		

Controller Parts

UDC Part#	Part Name		
10544	Actuator for Disconnect Switch		
08900	Contactora, A/B #100-C09D10		
13702	Fiber Optic Cable		
84386	FN Display Card		
80356	FN Touchpad		
84358	FN-X Main Card		
84372	FN-X2 Output Card		
09017	Fuse, 2.5 Amp, 250V, FNM		
08032	Mercury Contactor 35Amp		
19427	NVR Ram Chip(Memory Chip)		
19316	On/Off Rocker Switch, 1 Pole, 10A		
19483-R	Power Supply, 15 Watt		
11292	Thermocouple (Return & Process)		

UNIVERSAL DYNAMICS INC.

A Company of the MANN+HUMMEL Group

Title: Spare Parts - UDC-150 Dryers, 230V/460V

CMM- 04/05/04

230V Components

230V	UDC Part#	Part Name		
	03611	Afthtr/Process Htr, Ogden #A6W-2203		
	03576	Bedhtr/Regen Htr, Ogden #A6W-2194R		
	08902	Contactor, A/B #100-C16D10		
	10540	Disconnect Switch, 63 Amp		
	07163	Overload Relay 3.7 - 12Amp		
	08636	Transformer 230 Volt		

460V Components

460V	UDC Part#	Part Name		
	03614	Afthtr/Process Htr, Ogden #A6W-2201		
	03584	Bedhtr/Regen Htr, Ogden #A6W-2091R		
	10546	Disconnect Switch, 32 Amp		
	07162	Overload Relay, 1.6 - 5.0Amp		
	93000	Transformer 460 Volt		

Dewpoint Spare Parts

	UDC Part#	Part Name		
	19485	Dewpoint Sensor		
	HAR07-3	Dewpoint Cable		
	06031	Gasket f/Sensor		
	06033	Hex Nut		
	06026	Screen f/Sensor		
	11307	Sensor Housing		

*Note: Prices are subject to change without notice.

*Lead times that are provided are based on availability. Some lead times may vary.

Please contact the parts department for any further questions or information. You may fax your order direct to us for processing, we will provide a confirmation of your faxed order, if requested.

Direct Phone: 703-490-7009

Direct Fax: 703-490-7008

Email: customer.support@unadyn.com

REV. NO.	DESCRIPTION	DATE	APPROVAL

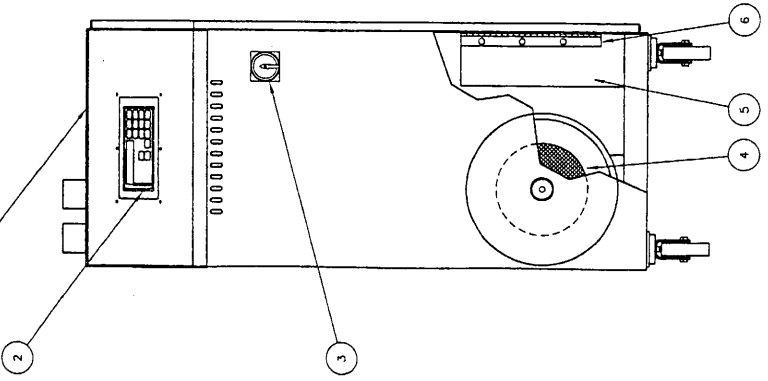
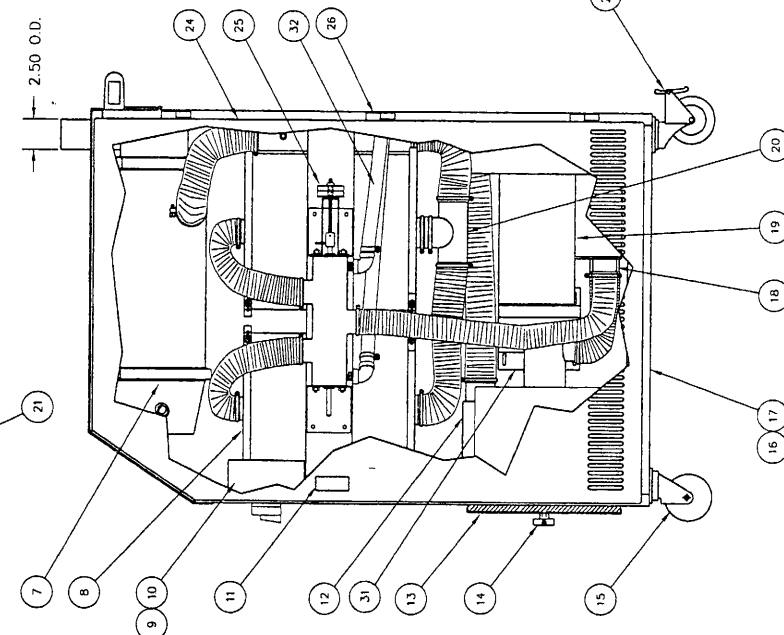
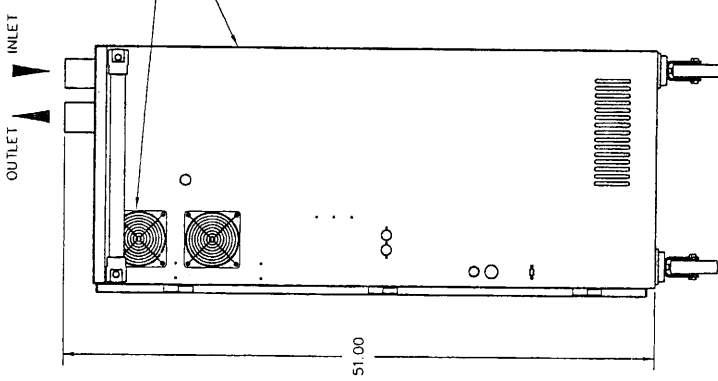
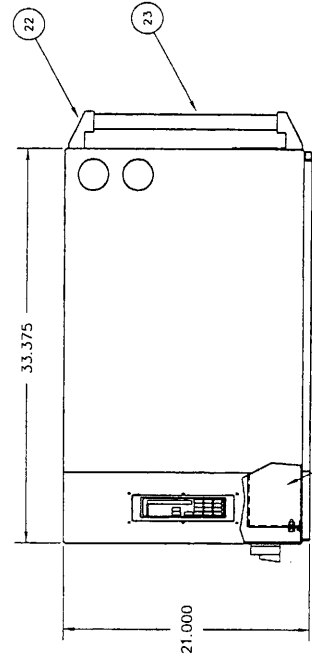

NOTE: 1. CASTERS NOT REQUIRED WHEN MACHINE IS MOUNTED ON COMMON STAND
 2. REMOVE ONLY ONE SECTION OF MOTOR MUFFLER FOAM TO INSTALL INLET/OUTLET PLATE
 3. USE STAINLESS STEEL POP RIVETS TO ASSEMBLE MACHINE. (POP RIVET STK# 71483)
 (POP RIVET STK# 71481, CABINET BASE ONLY)

FOR REPAIRS USE PART NUMBER ISSUE BEFORE USE

NO.	QTY.	DESCRIPTION
32	A/R	2918 HOSE, 3/4" I.D. NAPA #H152
31	1	51502001 BLOWER VENTILATION DUCT
30	1	51715000 CABINET WRAPPER
29	2	16347 GUARD, FAN
28	2	16346 FAN, COOLING
27	2	32042 CASTER, SWIVEL W/BRAKE, 4" (SEE NOTE 1)
26	3	48138 HINGE
25	1	49500300 VALVE ASSEMBLY
24	1	51715003 CABINET DOOR
23	1	33327 HANDLE
22	2	33326 STAY, HANDLE END
21	1	51915001 COVER, CONTROL BOX
20	1	50000011 TEE, 2.5" OD
19	1	50000007 MOTOR, 2.5HP
18	1	INLET/OUTLET PLATE, 2.5HP MOTOR (SEE NOTE 2)
17	1	51500009 BRACKET, BASE
16	1	51715002 CABINET, BASE
15	2	32040 CASTER, SWIVEL, 4" (SEE NOTE 1)
14	1	71451 HAND KNOB
13	1	54501300 COVER, FILTER
12	1	54501200 FILTER HOUSING, 12" OD X 10" LONG
11	1	48136 LATCH, LIFT & TURN
10	1	50000009 COVER, DISCONNECT
9	1	50000008 BRACKET, DISCONNECT
8	1	49000300 DESCENDANT BED ASSEMBLY
7	1	49500308 MUFFLER CENTER ASSEMBLY
6	1	50000010 COVER, CONTROL BOX
5	1	51915000 COVER, CONTROL BOX
4	1	31084 SWITCH, DISCONNECT
3	1	TOUCH PAPER CONTROLLER
2	1	51715001 CABINET, TOP

REV. NO.	DESCRIPTION	DATE	APPROVAL

NO.	QTY.	DESCRIPTION

NOTE: CONTROL BOX REMOVED FROM THIS VIEW FOR CLARITY

REV. NO.	DESCRIPTION	DATE	APPROVAL

REVISIONS		REV. 1/92
SYM.	DESCRIPTION	DATE
	REVISED STAND	12/83

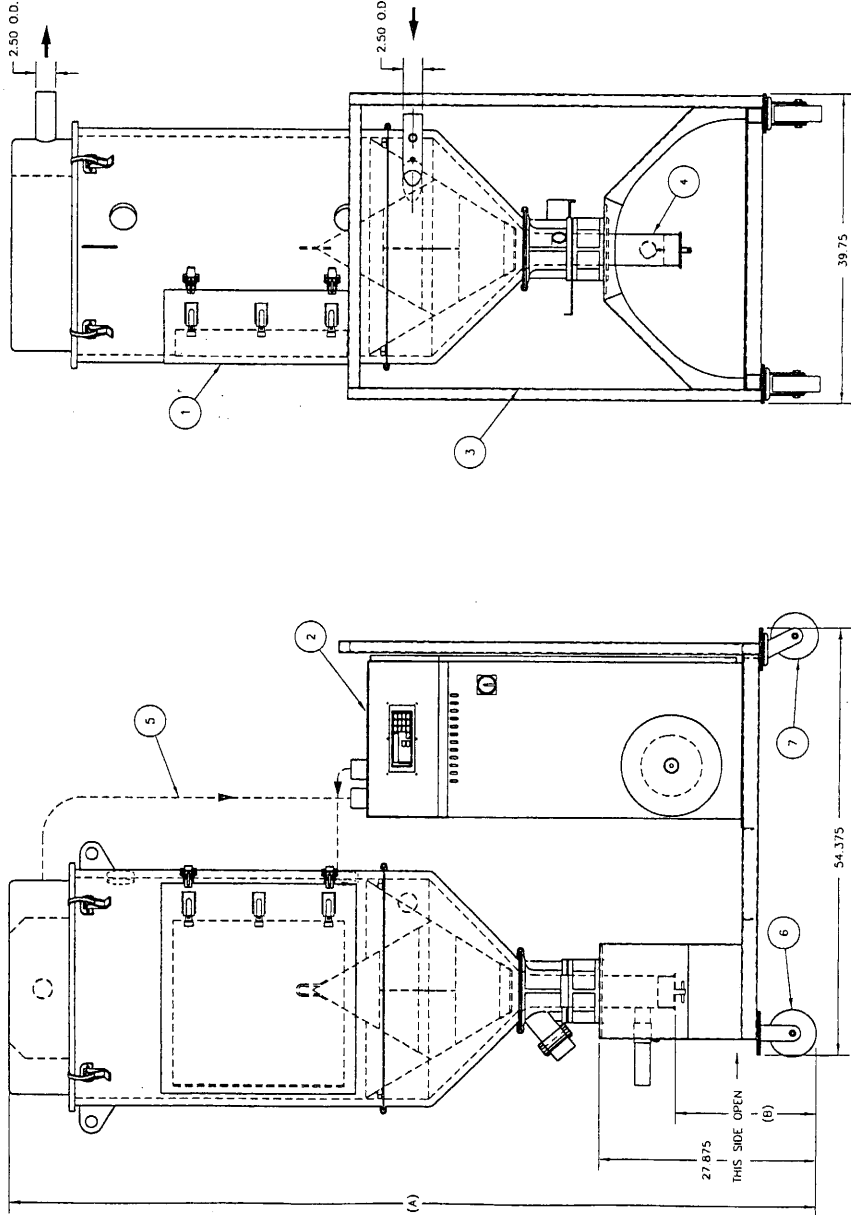

HOPPER SCH.

HOPPER	DWG. #	(A)
150 LB	850-00-153	78.25
200 LB	850-00-160	83.625
300 LB	850-00-155	89.25
400 LB	850-00-156	95.375
600 LB	850-00-157	103.50
800 LB	850-00-158	118.50

DRYER SCH.

DRYER	DWG. #
UDC-100	42510000
UDC-150	42515000

FOR REFERENCE ONLY
USER MUST VERIFY
ISSUE BEFORE USING

UDC DRYER NOT SHOWN F / CLARITY.

500 LB. MOD. HOPPER. (1) PORT VITA & UDC-100 SHOWN

ITEM NO.	QTY.	PART OR REPT. NO.	DESCRIPTION	APPROVED	DATE	APPROVED	DATE
7	2	32092	6" SWIVEL CASIER				
8	2	32091	5" RIGID CASIER				
9	1	REF. TO ORDER	2.50 HOSE				
10	1	REF. TO ORDER	TUBE STUB VIA				
11	1	467-30-005	COMMON STAND				
12	1	SEE SCH.	UDC DRYER				
13	1	SEE SCH.	MOD. HOPPER				

TITLE		UNIVERSAL DYNAMICS CORPORATION	
UDC-100/150 DRYER, & MOD. HOPPER ON COMMON STAND		DATE 11/93	ISSUE
DRYER	SWM	DATE 9/90	ISSUE
CHECKED	DJK	DATE	ISSUE
APPROVED	APPROVED	DATE 2/12/83	467-30-010

DO NOT SCALE THIS OR ANY DRAWING.

REVISIONS		
SPN	DESCRIPTION	DATE

REV. 1/92	APPROVAL

TO VTA BRANCH INLET
TO DRYER INLET
TO BLOWER OUTLET

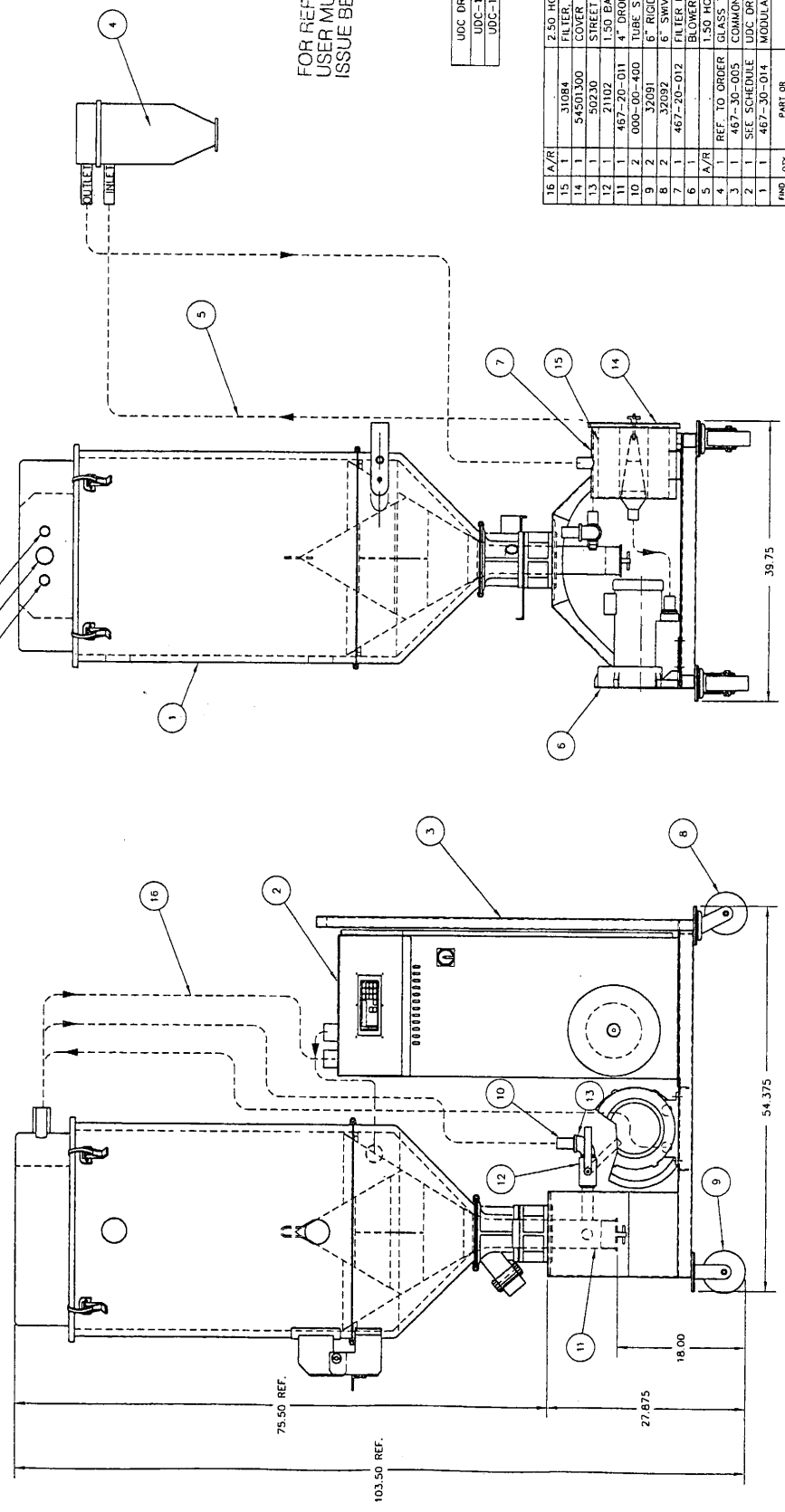

FOR REFERENCE ONLY
USER MUST VERIFY
ISSUE BEFORE USING

DRYER SCH.	
UDC DRYER	DWG #
UDC-100	42510000
UDC-150	42515000

NO	QTY	PART IDENT NO.	DESCRIPTION
16	A/R	2.50 HOSE	
15	1	31084	FILTER, 10.00 O.D. * 10.00 LONG
14	1	54001500	COVER FOR FILTER
13	1	30230	STREET ELBOW, 1.1/2
12	1	2104	1.50 BALL VALVE
11	1	467-20-011	1.50 BRG. STILE VIA, 1.50 NPT NIPPLE
10	2	000-CR-480	1.50 BRG. STILE
9	2	37089	6" SWG CASTER
8	2	37097	6" SWG CASTER
7	1	467-20-012	FILTER HOUSING
6	1	A/R	BLOWER (ROTRON #DR004)
5	A/R	1.50 HOSE	
4	1	REF TO ORDER	GLASS TUBE VACUUM RECEIVER
3	1	467-30-005	COMMON STAND
2	1	SEE SCHEDULE	UDC DRYER
1	1	467-30-014	MODULAR HOPPER

TITLE	
UDC-150/100 W/ 600 LB. HINGED HOPPER & 1 HP GMC-VCL	
DRAWN	DATE 3/96
CHECKED	DATE 10/98
APPROVED	DATE 11/93
ISSUE	

NOTES	
HANDLE & UDC DRYER NOT SHOWN FOR CLARITY	

SCALE	FLOOR	CUSTOMER
1/8		

DO NOT SCALE THIS OR ANY DRAWING

DO NOT SCALE THIS OR ANY DRAWING

DO NOT SCALE THIS OR ANY DRAWING

DO NOT SCALE THIS OR ANY DRAWING

UNIVERSAL DYNAMICS CORPORATION

UNIVERSAL DYNAMICS CORPORATION

UNIVERSAL DYNAMICS CORPORATION

UNIVERSAL DYNAMICS CORPORATION

UNIVERSAL DYNAMICS CORPORATION

UNIVERSAL DYNAMICS CORPORATION

UNIVERSAL DYNAMICS CORPORATION

REV.	DESCRIPTION	DATE	APPROVAL
1	REVISED HOSE CONNECTION	4/78	
2	ADDED NOTES TO VALVES AND VCL CHAMBERS	4/78	

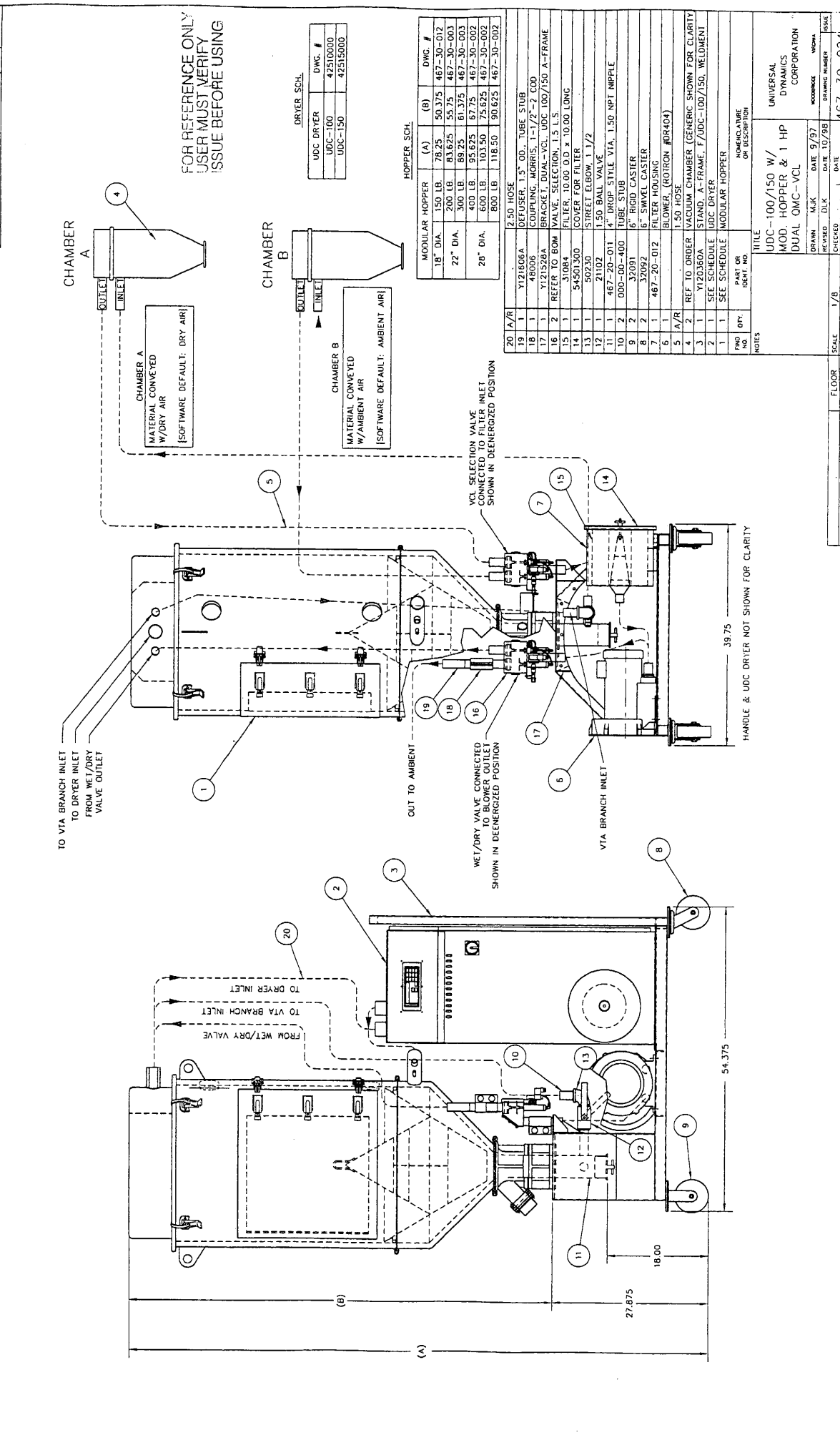

FOR REFERENCE ONLY
USER MUST VERIFY
ISSUE BEFORE USING

UDC DRYER	DWG. #
UDC-100	47510000
UDC-150	47515000

HOPPER SCH.		
MODULAR HOPPER (A)	(B)	DWG. #
18" DIA.	150 LB.	50.375 467-30-012
22" DIA.	200 LB.	63.625 55.75 467-30-003
	300 LB.	89.25 61.375 467-30-003
	400 LB.	95.625 67.75 467-30-002
	600 LB.	103.50 75.625 467-30-002
	800 LB.	118.50 90.625 467-30-002

20 A/R	DESCRIPTION
1	Y121506A
1	Y120996
1	Y121528A
2	REF. TO ORDER VACUUM CHAMBER (GENERIC SHOWN FOR CLARITY)
2	REF. TO ORDER MOD. HOPPER & 1 HP DUAL OMC-VCL
2	REF. TO ORDER STAND, A-FRAME, F/UDC-100/150, WELDMENT
2	SEE SCHEDULE UDC DRYER
2	SEE SCHEDULE MODULAR HOPPER
7	1 467-20-012
6	1 BLOWER, (ROIRON #DR404)
5	A/R 1.50 HOSE
4	2 REF. TO ORDER VACUUM CHAMBER (GENERIC SHOWN FOR CLARITY)
3	1 Y120360A
2	1 SEE SCHEDULE UDC DRYER
2	1 SEE SCHEDULE MODULAR HOPPER
1	1 SEE SCHEDULE UDC DRYER
1	1 SEE SCHEDULE MODULAR HOPPER

NOTES	
TITLE	UDC-100/150 W/ MOD. HOPPER & 1 HP DUAL OMC-VCL
UNIVERSAL DYNAMICS CORPORATION	
DRAWN	MJK
DATE	9/97
CHECKED	DJK
DATE	10/98
APPROVED	AWA
DATE	10/98
DRAWING NUMBER	467-30-024 F
ISSUE	1

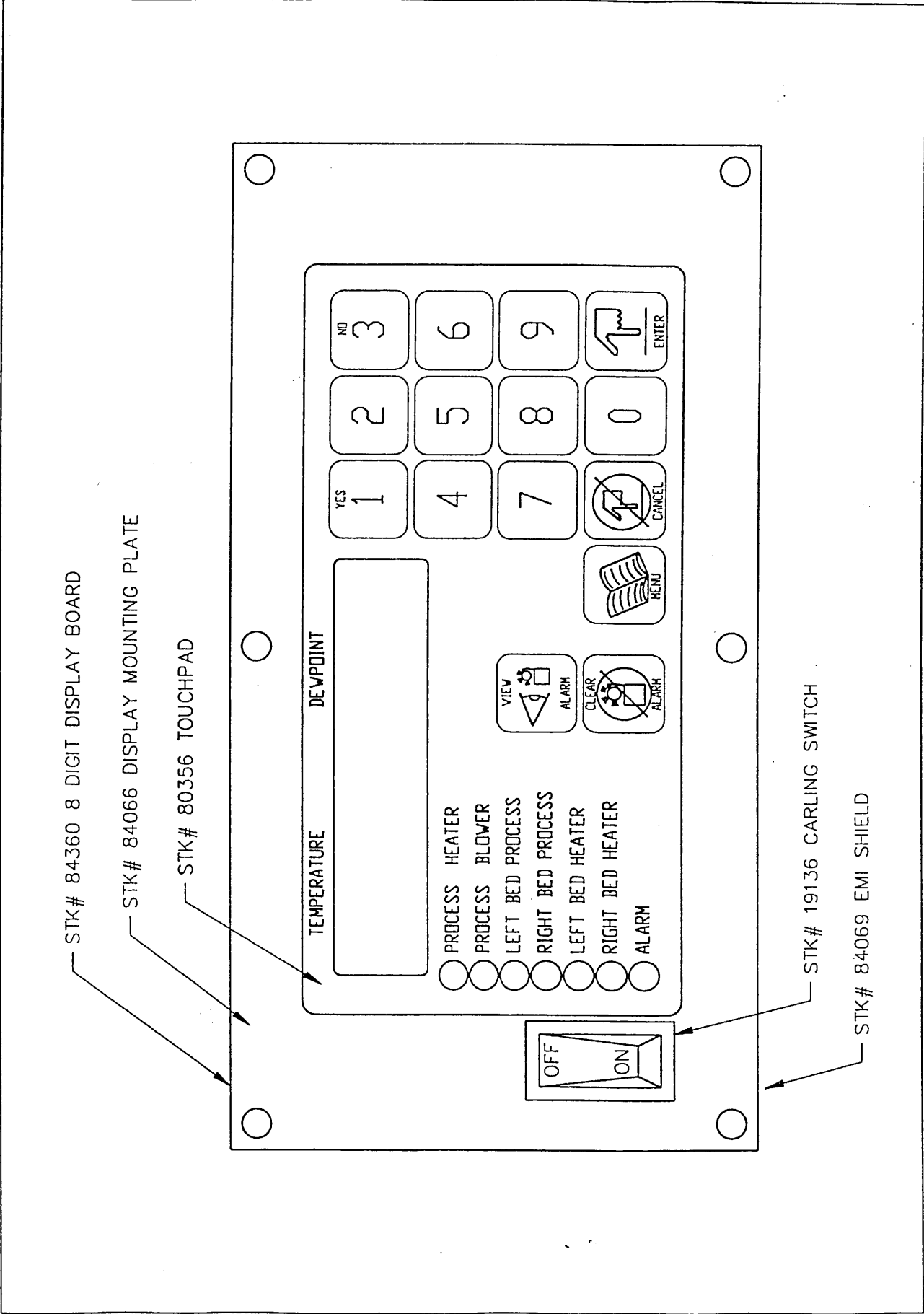

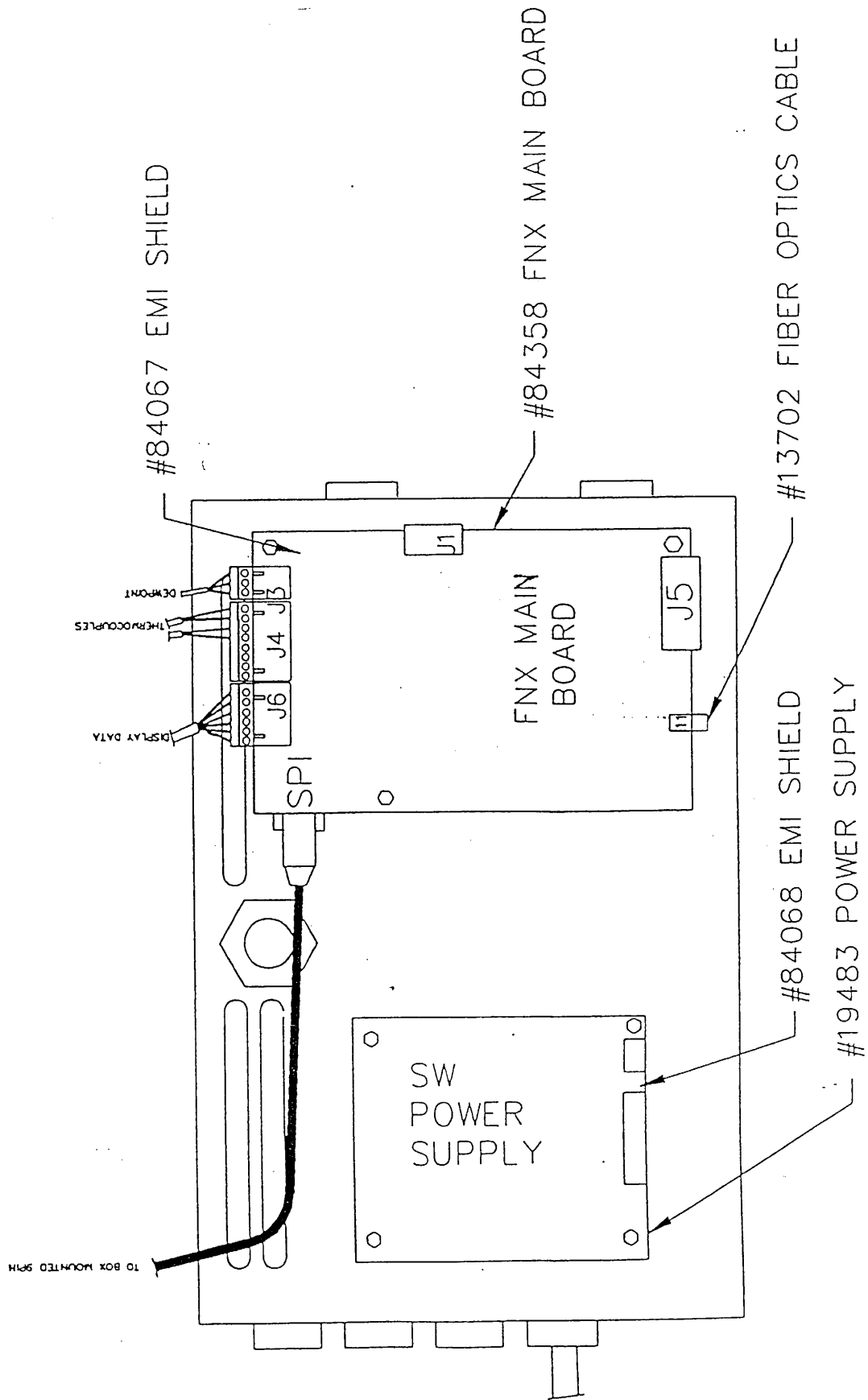

NOTE: UDC-55 AT 208V-230V
 USE FUSE BLOCK #10124
 ALL OTHERS USE #10118

#19931 MOTOR RELAY

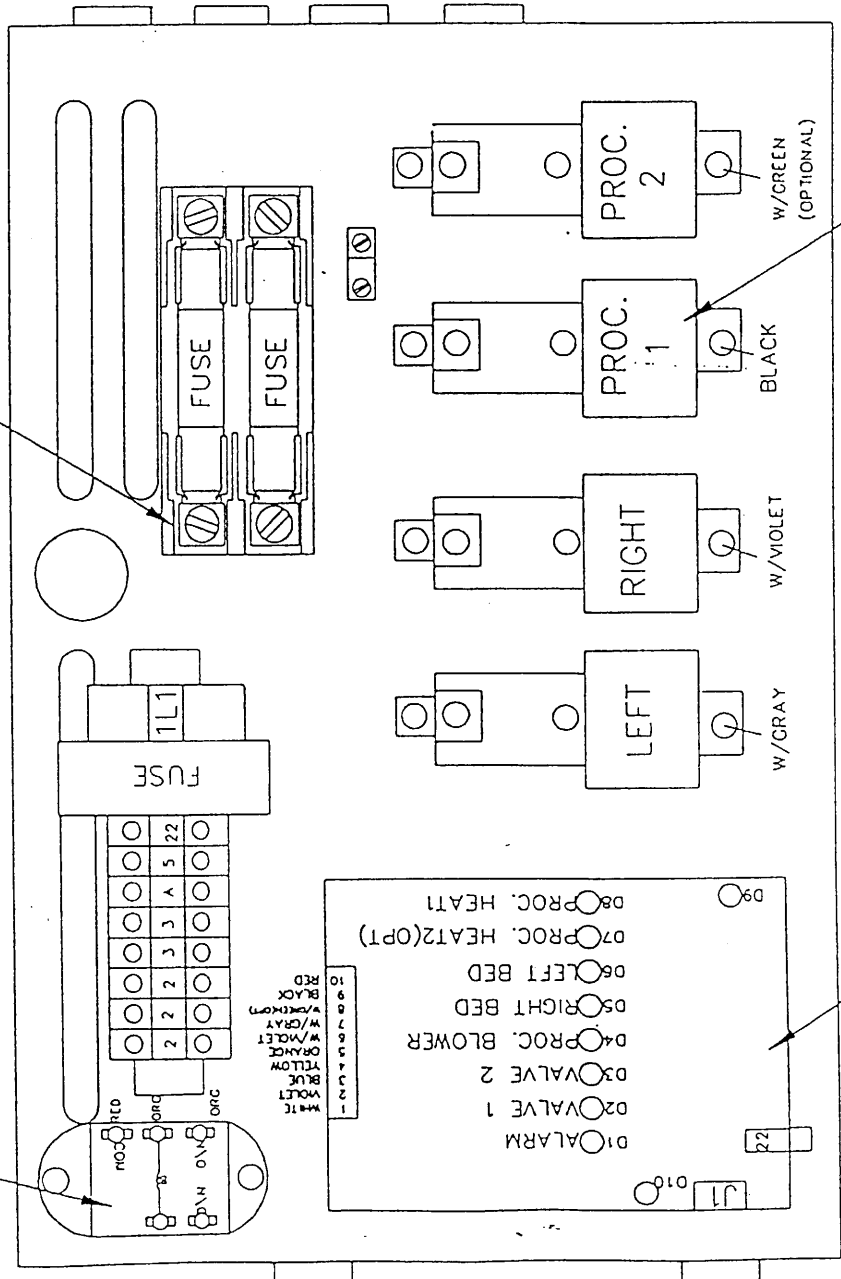

#84362 FN OUTPUT BOARD

#08041 MERC. CONTACTOR

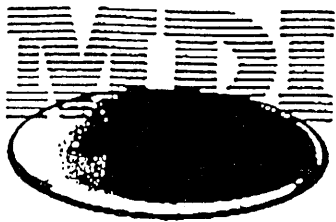

MERCURY DISPLACEMENT INDUSTRIES, INC.

Post Office Box "K" - U.S. 12 East - Edwardsburg, Michigan 49112-0711

Phone (616) 663-8574 Facsimile (616) 663-2924

Call Toll Free (800) 634-4077

RECOMMENDED HANDLING PROCEDURES for MERCURY DISPLACEMENT RELAYS

1) Proper fusing is required for Mercury Displacement Relays. The contacts must be protected by "LOW CURRENT PEAK FUSES", such as those listed below:

250 VOLT RATED

LPN-RK

KTN-R

JJN

600 VOLT RATED

LPS-RK

KTS-R

JJS

JKS

KTK-R

LPJ

2) Mercury Displacement Relays must operate with the coil voltage, full-on, or full-off. With partial voltage, the withstand spacing between the mercury pool and the electrode will be inadequate. With less than full operating voltage, inadequate coverage of mercury over the electrode, can result in run-away heat, that proper fusing will not offer protection from.

3) To insure that the relay is unlikely to fail in the closed position at or near the end of its life, a maintenance program should be used. A life expectancy chart can be used along with calculated cycle rates to determine the time to change the relays, before failure.

4) When the relay has seen the end of its life, it must be properly disposed of. These switches may be returned to the manufacturer for reclamation.



MERCURY DISPLACEMENT INDUSTRIES, INC.

Post Office Box "K" - U.S. 12 East - Edwardsburg, Michigan 49112-0711

Phone (616) 663-8574 Facsimile (616) 663-2924

Call Toll Free (800) 634-4077

SPILL AND LEAK PROCEDURES

Spilled mercury forms many tiny globules. A method for collection of spill, is to use water in a spray bottle to spray the entire contaminated area. A squeegee is then used to gather the globules into one mercury pool. One of the following methods can now be used to pick up the mercury pool:

A) Use a suction bulb to transfer the spill to an unbreakable polyethylene container with a tight sealing lid.

B) Take up with mercury absorbent material, and place into container for proper disposal.

C) Mercury spill kits can be purchased from chemical supply companies.

Reactivity DATA

Mercury is stable under normal temperature and pressure. It cannot undergo hazardous polymerization.

Decomposition: Thermal decomposition products may include highly toxic vapors of mercury and mercury oxides.

Chemical Incompatibilities Acetylene, Ammonia, Boron Phosphodilodide, Bromine, 3-Bromopropyne, Chlorine, Chlorine Dioxide, Methyl Azide, Peroxyformic acid and Sodium Carbide.

Material Safety Data Sheet

MERCURY

QUICK IDENTIFIER

Common Name: (used on label and list)

May be used to comply with OSHA's Hazard Communication Standard, 29CFR 1910. 1200. Standard must be consulted for specific requirements.

SECTION 1 -

Manufacturer's Name D.F. GOLDSMITH CHEMICAL & METAL CORP.

Address 909 Pitner Avenue

Emergency Telephone No. 800-424-9300

City, State, and ZIP Evanston, IL 60202

Other Information Calls 708-869-7800

Signature of Person Responsible for Preparation (Optional)

Date Prepared 7/1/92

SECTION 2 - HAZARDOUS INGREDIENTS/IDENTITY

Hazardous Component(s) (chemical & common name(s))	OSHA PEL	ACGIH TLV	Other Exposure Limits	% (optional)	CAS NO.
MERCURY (METALLIC MERCURY) (QUICKSILVER)	0.05 MG(HG)/M ³	0.05 MG(HG)/M ³ TWA	100		7439-97-6

SECTION 3 - PHYSICAL & CHEMICAL CHARACTERISTICS

Boiling Point 675 F (357 C) Specific Gravity (H₂O=1) 13.6 Vapor Pressure (mm Hg) 0.0012 MMHG @ 20C

Vapor Density (Air=1) 7.0

Solubility in Water Insoluble Reactivity in Water N.A.

Appearance and Odor Silver-White, Heavy Mobile, Liquid Metal Melting Point -38 F (-39 C)

SECTION 4 - FIRE & EXPLOSION DATA

Flash Point N/A F. C. Method Used Flammable Limits in Air % by Volume LEL Lower N/A UEL Upper

Auto-Ignition Temperature N/A Extinguisher Media Dry Chemical, Carbon Dioxide, Water Spray or Foam (1984 Emergency Response Guidebook, DOT P 5800.3)

Special Fire Fighting Procedures For larger fires, use water spray, fog or alcohol foam (1984 Emergency Response Guidebook, DOT P 5800.3) Firefighting: Move containers from area if possible.

Cool containers exposed to flames with water from side until well after fire is out (1984 Emergency Response Guidebook, DOT P 5800.3) Use agents suitable for type of fire;

Unusual Fire and Explosion Hazards Use water in flooding amounts as a fog. Avoid breathing corrosive and poisonous vapors. Keep upwind.

SECTION 5 - PHYSICAL HAZARDS (REACTIVITY DATA)

Stability Unstable Stable Conditions to Avoid Does not ignite readily. Flammable, poisonous gases may accumulate in tanks & hopper cars. May ignite combustibles (wood, paper, oil)

Incompatibility (Materials to Avoid) Violent Reaction: Acetylinic Compounds; Ammonia; Boron; Diiodophosphide; Ethylene Oxide; Metals (Aluminum; Potassium; Lithium; Sodium; Rubidium);

Methyl Azide; Methylsilane; Oxygen; Oxidants (Bromine; Peroxyformic Acid; Chlorine Dioxide; Nitric Acid; Tetracarbonylnickel; Nitromethane; Silver Perchlorate

Hazardous Decomposition Products Thermal decomposition products include toxic mercury vapors & oxygen.

Hazardous Polymerization May Occur Will Not Occur Conditions to Avoid None Known

SECTION 6 - HEALTH HAZARDS

Elemental Hg, liquid and vapor, is toxic due to its liquid solubility, lack of charge, and membrane permeability. Inhaled vapors (80%) diffuse rapidly through alveolar membranes into the blood and are systemically transported to body tissues, including the brain. Exposure to high conc. (1.2 mg/m³) of vapors for brief periods can cause pneumonitis, chest pains, dyspnea, coughing,; Later stomatitis, gingivitis, and salivation occur. Hg can be absorbed slowly through the skin. Chronic symptoms involve the CNS with tremors and various neuropsychiatric disturbances. The TLV would be exceeded if the contents of a small Hg clinical thermometer were dispersed in a closed 100' x 100' x 15' room. GI uptake of Hg is low (5%).

FIRST AID:

Eye Contact: Flush with running water for 15 min. including under the eyelids.

Skin Contact: Remove contaminated clothing. Wash affected area with soap and water.

Inhalation: Remove to fresh air. Restore and/or support breathing as needed. Administer O₂ for chem. pneumonitis.

Ingestion: Gastric lavage with 5% solution of sodium formaldehyde sulfoxylate, followed by 2% NaHCO₃, and finally leave 250 cc of the sodium formaldehyde sulfoxylate in the stomach.

Seek medical assistance for further treatment, observation and support.

Skin Contact: Irritant/Sensitizer/Neurotoxin/Nephrotoxin.

Acute Exposure - May cause redness and irritation. Sensitization Dermatitis may occur in previously exposed workers. Substance may be absorbed through intact skin causing anuria.

ROUTES OF ENTRY

Eye Contact: Irritant. Acute Exposure - Contact may cause irritation. Solutions are corrosive and may cause corneal injury or burns. Chronic Exposure - Mercury may be deposited in the lens of the eye, causing visual disturbances.

Ingestion: Neurotoxic/Nephrotoxic. Acute Exposure - When ingested, necrosis begins immediately in the mouth, throat, esophagus and stomach. Within a few minutes, violent pain, profuse vomiting, and severe purging may occur. Patient may die within a few minutes from fluid/electrolyte losses and peripheral vascular collapse, but death (from uremia) is usually delayed 6 to 12 days.

Inhalation: Irritant/Sensitizer/Neurotoxin. 28 MG/M³ immediately dangerous to life or health. Acute Exposure - Inhalation of a high concentration of mercury vapor can cause almost immediate dyspnea, cough, fever, nausea and vomiting, diarrhea, stomatitis, salivation and metallic taste. Symptoms may resolve or may progress to necrotizing bronchiolitis, pneumonitis, pulmonary edema, and pneumothorax. This syndrome is often fatal in children. Acidosis and renal damage with renal failure may occur. Inhaling volatile organic mercurials in high concentrations causes metallic taste, dizziness, clumsiness, slurred speech, diarrhea, and sometimes, fatal convulsions. Chronic Exposure - Inhalation of mercury vapor, dusts, over a long period causes mercurialism. Findings extremely variable & include tremors, salivation, stomatitis, loosening of teeth, blue lines on gums, pain & numbness in extremities, nephritis, diarrhea, anxiety, headache, weight loss, anorexia, mental depression, insomnia, irritability & instability, hallucinations and evidence of mental deterioration.

SECTION 7 - SPECIAL PRECAUTIONS AND SPILL/LEAK PROCEDURES

Store in closed unbreakable containers (polyethylene) in a cool, dry, well-ventilated area away from sources of heat. Protect containers from physical damage.

Mercury evaporates very slowly. Spilled Hg forms many tiny globules that will evaporate faster than a single pool and can develop a significant concentration of vapors in an unventilated area. Such vapors can be poisonous, especially if breathed over a long period of time. Heated Hg evolves high levels of toxic vapors.

DO NOT TOUCH SPILLED MATERIAL. STOP LEAK IF YOU CAN DO IT WITHOUT RISK. FOR SMALL SPILLS, TAKE UP WITH SAND OR OTHER ABSORBENT MATERIAL AND PLACE INTO CONTAINERS FOR LATER DISPOSAL. A MERCURY SPILL KIT MAY ALSO BE USED FOR SMALL SPILLS IN THE WORKPLACE. FOR LARGER SPILLS, DIKE FAR AHEAD OF SPILL FOR LATER DISPOSAL. KEEP UNNECESSARY PEOPLE AWAY. ISOLATE HAZARD AREA AND DENY ENTRY.

SECTION 8 - SPECIAL PROTECTION INFORMATION/CONTROL MEASURES

Provide adequate exhaust ventilation to meet TLV requirements in the workplace. Operations requiring an Hg surface should reduce the temp. of Hg to limit vaporization and minimize vapor exposure by using a local exhaust.

Self-contained breathing apparatus can be used up to 5 mg/m³ with a full facopiece above 1 mg/m³. Positive pressure-type air supplied breathing equipment has been recommended above 5 mg/m³.

Avoid eye contact by use of chemical safety glasses. Wear rubber gloves and protective clothing appropriate for the work situation. Separate work and street clothing. Store work clothing in special lockers. Showers to be taken before changing to street clothes.

Provide preplacement and periodic medical exams for those regularly exposed to Hg, with emphasis directed to CNS, skin, lungs, liver, kidneys and G.I. tract.



MATERIAL SAFETY DATA SHEET

1. CHEMICAL PRODUCT AND COMPANY INFORMATION

Product Name: Molsiv Adsorbents 13X 8x12

Product Use: Adsorbent

UOP LLC
25 E. Algonquin Road
Des Plaines, IL 60017-5017
USA
Tel: +1-847-391-3189
Fax: +1-847-391-2953

UOP M.S. S.p.A.
Viale Milanofiori
Strada 1 - Palazzo E1
20090 Assago Mi, Italy
Tel : +39-02-57540.214
Fax : +39-02-57500.109/145

Emergency Assistance - 24 hour Emergency Telephone Numbers:

USA (UOP LLC) : + 1-847-391-2123
USA (CHEMTREC) : + 1-800-424-9300
Canada (CANUTEC) : + 1-613-996-6666
Outside USA (CHEMTREC) : + 1-703-527-3887

2. COMPOSITION/INFORMATION ON INGREDIENTS

<u>INGREDIENT & CAS No</u>	<u>% WEIGHT</u>	<u>ACGIH TLV-TWA</u>	<u>OSHA PEL-TWA</u>	<u>UNITS</u>
Silicon oxide (synthetic) 7631-86-9	< 60	10(I) 3(R)	15(TD) 5(R)	mg/m ³
Aluminum oxide (non- fibrous) 1344-28-1	< 40	10	15(TD) 5(R)	mg/m ³
Sodium oxide 1313-59-3	< 20	N.E.	N.E.	N.A.
Magnesium oxide 1309-48-4	< 5	N.E.	N.E.	N.A.
Quartz 14808-60-7	< 3	0.1(R)	TD: 30/(%SiO ₂ +2) RD: 10/(%SiO ₂ +2)	mg/m ³

Note: The OSHA Permissible Exposure Limits (PEL) are determined from the percentage of quartz from airborne samples.

Abbreviations:

N.A.	- Not Applicable	RD	- Respirable Dust	Fu	- Fume
N.E.	- None Established	TD	- Total Dust	I	- Inhalable
SC	- Soluble Compounds	FuD	- Fume and Dust	R	- Respirable

3. HAZARDS IDENTIFICATION

Emergency Overview

In the fresh unused state, this product is not flammable. When first wetted, the product can heat up to the boiling point of water. Flood with water to cool material. Repeated and prolonged inhalation of crystalline silica in the form of quartz from occupational sources may cause cancer.

Form: Beads

Color: Tan

Potential Health Effects:

- Primary Routes of Exposure:** Contact with skin and eyes. Exposure may also occur via inhalation or ingestion if product dust is generated.
- Skin Contact:** May cause skin irritation. The product gets hot as it first adsorbs water.
- Eye Contact:** Dust and /or product may cause eye discomfort and/or irritation seen as tearing and reddening.
- Ingestion:** The product gets hot as it first adsorbs water. Burns to moist body tissues can result if contact is prolonged.
- Inhalation:** Exposure to dust particles generated from this material may cause irritation of the respiratory tract. Repeated and prolonged inhalation of crystalline silica in the form of quartz from occupational sources may cause cancer.
- Target Organ:** Prolonged or repeated inhalation may cause lung injury/cancer.

Carcinogenicity Classification:

International Agency for Research on Cancer (IARC):

Silicon Oxide (synthetic) - Unclassifiable as to carcinogenicity in humans (Group 3). Inhaled crystalline silica in the form of quartz from occupational sources is carcinogenic to humans (IARC Group 1).

U.S. National Toxicology Program (NTP):

Quartz - Reasonably anticipated to be a human carcinogen.

U.S. Occupational Safety and Health Administration (OSHA):

Neither the product nor the components are classified or regulated.

American Conference of Governmental Industrial Hygienists (ACGIH):

Aluminum oxide - Not Classifiable as a Human Carcinogen (A4).

4. FIRST AID MEASURES

- 4.1 **Eye contact:** Rinse immediately with plenty of water for at least 15 minutes. If eye irritation persists, consult a physician.
- 4.2 **Skin contact:** Wash off with soap and plenty of water. If skin irritation persists, call a physician.
- 4.3 **After inhalation:** Remove the victim into fresh air. If symptoms persist, call a physician.
- 4.4 **After ingestion:** Immediately give large volume of water to drink. If symptoms persist, call a physician.
- 4.5 **Notes to physician:** This product is a desiccant and generates heat as it adsorbs water. The used product can contain material of a hazardous nature. Identify that material and treat symptomatically.

5. FIRE FIGHTING MEASURES

- 5.1 **Suitable extinguishing media:** Non-combustible. Use extinguishing media for surrounding fire.
- 5.2 **Unsuitable extinguishing media:** N.A.
- 5.3 **Fire and explosion hazards:** Standard procedure for chemical fires. The product itself does not burn. The used product can retain material of a hazardous nature. Identify that material and inform the fire fighters.
- 5.4 **Special protective equipment:** In the case of respirable dust and/or fumes, use self-contained breathing apparatus and dust impervious protective suit.
- 5.5 **Flash Point:** N.A.

6. ACCIDENTAL RELEASE MEASURES

- 6.1 **Personal protection:** See 8.2
- 6.2 **Environmental precautions:** No special environmental precautions required.
- 6.3 **Clean-up:** Sweep, shovel or vacuum spilled product into appropriate containers (do not use a vacuum if material has contacted a hydrocarbon material). Pick-up and arrange disposal without creating dust. Never use spilled product. Spilled product should be disposed in accordance with all applicable government regulations.

7. HANDLING AND STORAGE

- 7.1 **Handling:** Handle and open container with care. Avoid formation of respirable particles. Avoid contact with skin and eyes. Take precautionary measures against static discharges. A copy of UOP's booklet, "Precautions and Safe Practices for Handling Molecular Sieves in Process Units", M-100C, can be obtained from your UOP representative at no cost.
- 7.2 **Storage:** Store in original container. Keep in a dry place.

8. EXPOSURE CONTROLS/PERSONAL PROTECTION

- 8.1 **Engineering measures:** Ensure adequate ventilation, especially in confined areas.
- 8.2 **Personal protection equipment:** Handle in accordance with good industrial hygiene and safety practice.
- Eye protection:** Safety glasses. Avoid contact with eyes.
- Hand protection:** Protective gloves.
- Skin and body protection:** Dust impervious protective suit.
- Respiratory protection:** In case of insufficient ventilation wear suitable respiratory equipment. Breathing apparatus with filter: classification N-100 or if oil/liquid aerosols are present P-100 (42 CFR 84).

9. PHYSICAL AND CHEMICAL PROPERTIES

These data do not represent technical or sales specifications.

9.1 Form:	Beads
9.2 Color:	Tan
9.3 Odor:	None
9.4 pH:	N.A.
9.5 Boiling point/range:	N.A.
9.6 Melting point/range:	N.A.
9.7 Flash point:	N.A.
9.8 Autoignition temperature:	N.A.
9.9 Bulk density:	No data available.
9.10 Explosion limits:	N.A.
9.11 Vapor pressure:	N.A.
9.12 Relative density:	N.A.
9.13 Vapor density:	N.A.
9.14 Viscosity:	N.A.
9.15 Water solubility:	No data available.
9.16 Solubility:	No data available.

Abbreviations:

AS - Aqueous slurry

10. STABILITY

- 10.1 Stability: Stable.
- 10.2 Hazardous decomposition products: No decomposition if used as directed. Hydrocarbons and other materials that contact the product during normal use can be retained on the product. It is reasonable to expect that decomposition products will come from these retained materials of use.
- 10.3 Conditions/Materials to avoid: Sudden contact with high concentrations of chemicals having high heats of adsorption such as olefins, HCl, etc. When first wetted, the product can heat up to the boiling point of water. Flood with water to cool material.

11. TOXICOLOGICAL INFORMATION

11.1 Acute toxicity:

LD50/oral/rat = > 32 000 mg/kg *

LD50/dermal/rabbit = No data available.

LC50/inhalation/rat = No data available.

11.2 Chronic toxicity: Classification of Ingredients

EC Carcinogenic: Not listed.

EC Mutagenic: Not listed.

EC Toxic for Reproduction: Not listed.

Carcinogenicity (ACGIH): A4 (Aluminum oxide)

IARC classification: Group 3 (Silicon oxide - synthetic)
Group 1 (Quartz)

11.3 Routes of exposure: Exposure may occur via inhalation, contact with skin and eyes.

11.4 Irritation:

Skin (rabbit): Not classified as a skin irritant in animal testing. *

Eye (rabbit): Moderate eye irritation *

11.5 Additional information: * The toxicological data have been taken from products of similar composition.

12. ECOLOGICAL INFORMATION

- 12.1 Mobility: No data available.
- 12.2 Biodegradation: No data available.
- 12.3 Bioaccumulation: No data available.
- 12.4 Aquatic toxicity: No data available.
- 12.5 Further Information: No information available.

13. DISPOSAL CONSIDERATIONS

- 13.1 Provisions relating to waste: EPA - Resource Conservation and Recovery Act (RCRA) Hazardous and Solid Waste Management Regulations.
- 13.2 Disposal information: This product (in its fresh unused state) is not listed by generic name or trademark name in the U.S. EPA's RCRA regulations and does not possess any of the four identifying characteristics of hazardous waste (ignitability, corrosivity, reactivity or toxicity). Materials of a hazardous nature that contact the product during normal use may be retained on this product. The user of the product must identify the hazards associated with the retained material in order to assess the waste disposal options.

14. TRANSPORT INFORMATION

- 14.1 Proper shipping name Not applicable.
- 14.2 UN-No N.A.
Packaging group N.A.
- 14.3 U.S. DOT Not regulated.
DOT Shipping name N.A.
Hazard classification N.A.
- 14.4 IMO Not regulated.
EmS N.A.
MFAG N.A.
Marine pollutant No
- 14.5 ICAO - IATA Not regulated.
Instruction "passenger": N.A.
Instruction "cargo": N.A.
- 14.6 Further Information
Not classified as hazardous or dangerous in the meaning of transport regulations.

15. REGULATORY INFORMATION

United States

Toxic Substances Control Act (TSCA):

All the ingredients of this mixture are registered in the TSCA Chemical Substance Inventory.

CERCLA (Comprehensive Environmental Response, Compensation, and Liability Act) Reportable Quantity:

The following component(s) of this product is/are subject to release reporting under 40CFR 302 when release exceeds the Reportable Quantity (RQ):

-- None --

SARA Title III (Superfund Amendments and Reauthorization Act of 1986):

Section 302 (Extremely Hazardous Substances):

The following component(s) of this product is/are subject to the emergency planning provisions of 40CFR 355 when there are amounts equal to or greater than the Threshold Planning Quantity (TPQ):

-- None --

Section 313 (Toxic Chemicals):

The following component(s) have been specified as Toxic Chemicals under SARA Section 313 and may be subject to the Toxic Release Inventory (TRI) reporting requirements under 40 CFR 372:

-- None --

The following components are listed in U.S. State Regulations:

<u>State Reg Reference:</u>	<u>Component(s)</u>
California - Proposition 65:	Silica, crystalline
Massachusetts Right-To-Know:	Quartz Aluminum oxide
New Jersey Right-To-Know:	Silica, amorphous Aluminum oxide Silica, quartz
Pennsylvania Right-To-Know:	Silica Aluminum oxide Quartz Magnesium oxide

Note: Other U.S. State Regulations may exist, check your local sources if available or contact the UOP Product Stewardship Manager (see Section 16).

Canada

Canadian Hazardous Products Act:

This product is classified as a material causing other toxic effects, carcinogenicity - Class D, Division 2, Subdivision A, under regulations pursuant to the Federal Hazardous Products Act (e.g. WHMIS)

Canadian Environmental Protection Act:

All the ingredients of this mixture are notified to CEPA and on the DSL (Domestic Substances List).

European Union (EU)

European Inventory of Existing Commercial Chemical Substances:

All components of this product are included in EINECS/ELINCS.

Council of European Communities Directive on Classification, Packaging and Labelling of Dangerous Substances/Preparation (67/548/EEC & 88/379/EEC):

No Dangerous Goods Label Required.

16. OTHER INFORMATION

Summary of changes: New MSDS
Supersedes: None.
Prepared by: UOP Health, Safety & Environmental Department

HMIS™ - Hazardous Material Information System:

HMIS™ Ratings: 0-minimal hazard, 1- slight hazard, 2- moderate hazard, 3- serious hazard, 4- severe hazard.

HEALTH : 1* - * may cause cancer
FLAMMABILITY : 0
REACTIVITY : 0

For additional information concerning this product, contact the following:

**For health, safety and environmental information,
please contact:**

**For technical or
purchasing information,
please contact:**

Product Stewardship Manager UOP LLC 25 E. Algonquin Road Des Plaines, IL 60017-5017 USA Tel: +1 (847) 391 3189 Fax: +1 (847) 391 2953	Product Safety Steward Europe UOP N.V. Noorderlaan 147 B-2030 Antwerpen Belgium Tel: +32 (3) 5409 971 Fax: +32 (3) 5417 806	Adsorbent Sales UOP - Molsiv Dept. 13105 Northwest Freeway Suite 600 Houston, TX 77040 USA Tel: +1-713-744-2811 Fax: +1-713-744-2802
---	---	--

PRODUCT EMERGENCIES

If you have a product-related emergency, resulting in an incident such as a spill or release of product or human exposure and need assistance from UOP, please contact the following number :

24-Hour EMERGENCY NUMBER (UOP LLC) : + 1 - 847 - 391 - 2123

The data and recommendations presented in this data sheet concerning the use of our product and the materials contained therein are believed to be accurate and are based on information which is considered reliable as of the date hereof. However, the customer should determine the suitability of such materials for his purpose before adopting them on a commercial scale. Since the use of our products by others is beyond our control, no guarantee, express or implied, is made and no responsibility assumed for the use of this material or the results to be obtained therefrom. Information on this form is furnished for the purpose of compliance with Government Health and Safety Regulations and shall not be used for any other purposes. Moreover, the recommendations contained in this data sheet are not to be construed as a license to operate under, or a recommendation to infringe, any existing patents, nor should they be confused with state, municipal or insurance requirements, or with national safety codes.

PLASTIC CONTAMINATION

In the event that plastic material has been exposed to foreign substances and has become contaminated, it is imperative that the instructions below be followed:

1. Stop the machine immediately.
2. Drain material from the system.
3. Find the source of contamination.
4. Correct problem. If the problem is silicone sponge gasket protruding into the interior of the vessel, see the trimming instructions which follow.
5. Clean and inspect complete system prior to restarting.
6. Do not reuse drained material unless it is contamination free.

This drawing is the property of UNIVERSAL DYNAMICS INC. This drawing is loaned with the expressed agreement that the drawing and information therein contained are the property of Universal Dynamics Inc. and shall not be copied, reproduced, or otherwise disposed of directly or indirectly, and will not be used in whole or in part to assist in making or to furnish any information, or to assist in the making of apparatus or reproductions thereof, for the making of apparatus or parts thereof, except upon written permission of Universal Dynamics Inc. The user's acceptance of this drawing will be construed as an acceptance of the foregoing agreement.

SPONGE GASKETING WORK INSTRUCTIONS

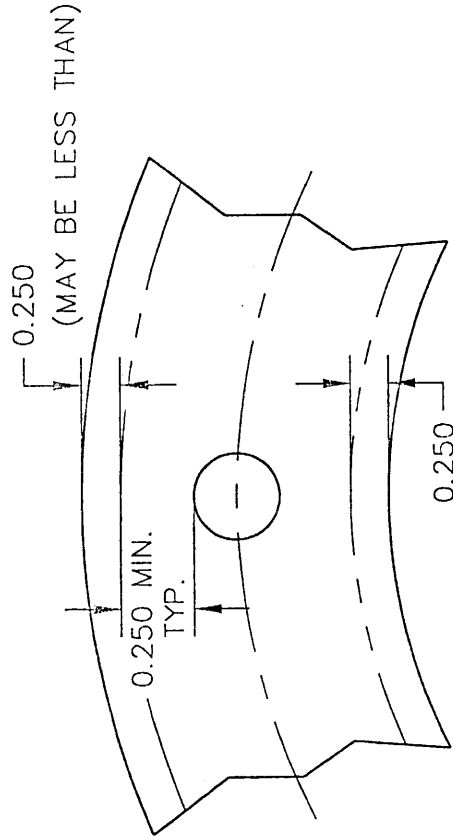
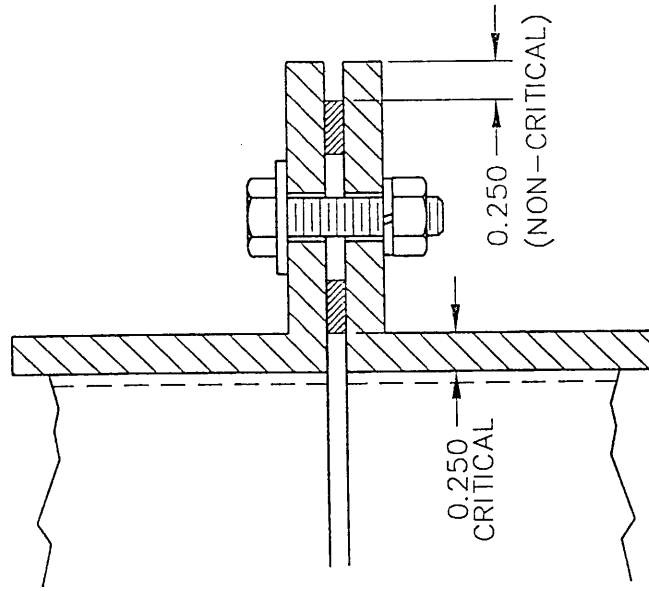

ANGLE DETAIL

- NOTE:
1. THIS INSTRUCTION FOR USE OF SILICONE SPONGE GASKETING ONLY.
 2. TO PREVENT CONTAMINATION OF PROCESS MATERIAL, IT IS IMPORTANT THAT GASKETING DOES NOT EXTEND PAST INNER WALL OF HOPPER OR COME INTO CONTACT WITH FLOW OF MATERIAL.
 3. AFTER INSTALLATION, GASKETING TO BE CUT WITH RAZOR OR SHARP KNIFE TO DIMENSIONS SHOWN ABOVE.

REVISION HISTORY		12/95
REV.	DESCRIPTION OF REVISION	DATE
-		-
-		-

DO NOT SCALE THIS OR ANY DRAWING	TITLE GASKETING WORK INSTRUCTIONS	DRAWN: MJK DATE: 12/97
FABRICATION TOLERANCES	DNC: 0.015	DATE
MFG: 0.031	(UNLESS SPEC'D)	REVISED
SCALE: FULL	CHECKED	DATE
JOB NO.	APPROVED	DATE

WOODBRIDGE, VIRGINIA, USA
DRAWING NUMBER
Y250461B

NOTICE:

USING THIS SIMPLIFIED INSTRUCTION SHEET DOES NOT NEGATE THE NEED TO READ THE COMPLETE MANUAL FOR OPERATIONAL AND SAFETY INSTRUCTIONS. THE FN IS A SOPHISTICATED CONTROLLER AND, JUST LIKE LEARNING TO WALK, YOU HAVE TO CRAWL FIRST. YOU SHOULD MASTER BASIC FUNCTIONS BEFORE ATTEMPTING COMPLICATED PROGRAMMING.

Getting Started - Some facts in a "Nutshell" for UDC Style Dryer with F/N Controller

1. Setup the dryer and hopper; attach air hoses from dryer to hopper as required.

Note: The dryer must be mounted upright - Inlet and Outlet on top of unit. See illustration at right.

2. Install plug to power cord or install at Disconnect and supply electricity to unit.

3. Turn electricity "ON" to unit.

4. Dry Cycle before processing Material:

Dry cycle the dryer at 32 degrees Fahrenheit (0 degrees Centigrade) with no material in the hopper. This is used to purge the desiccant of residual moisture. Dry cycle for 2 hours .

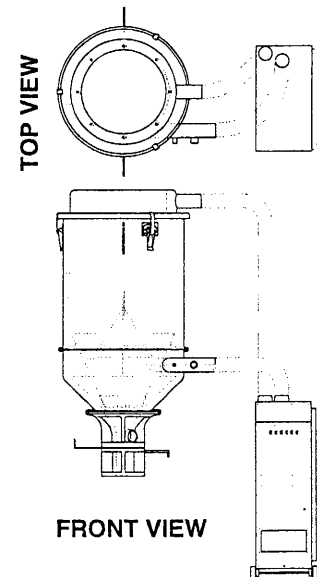

Function Codes:

Enter Function Code(s) for desired operation:

To view Message Window displays:

Each press of Menu Push-Button will advance forward thru codes one at a time.

Each press of View Alarm Push-Button will retreat backwards thru function codes one at a time.

If Function Code is known:

Press Menu Push-Button

Enter Function Code

Press Enter Push-Button

Review Function Code displayed in Message Window - if correct press

Enter Push-Button again

Enter desired setting if required

Press Enter Push-Button

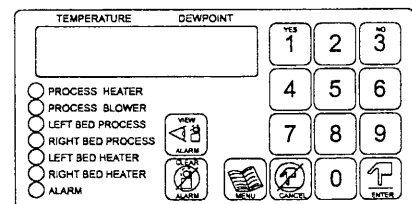

Setpoint:

the following example for changing Setpoint may help:

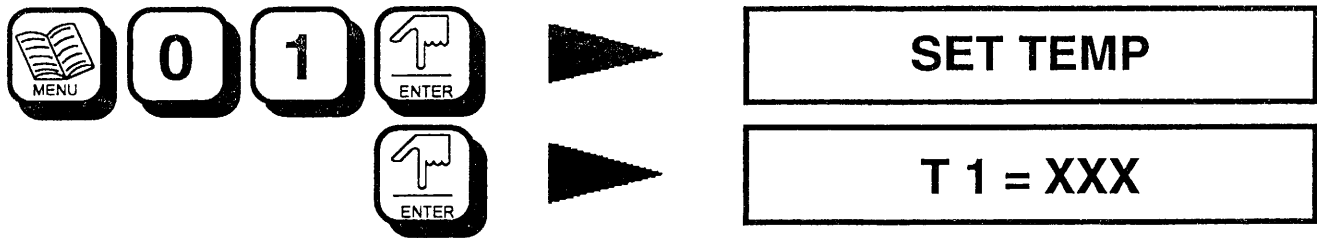

AT THIS POINT ENTER YOUR DESIRED SETPOINT



IN THIS EXAMPLE YOU HAVE ENTERED IN A SETPOINT OF 32 DEGREES FAHRENHEIT - NUMBER DISPLAYED IN MESSAGE WINDOW.

Drying Material:

Fill hopper with material. Set process heat to appropriate temperature for material (now ready to run)

Viewing Alarms:

Pressing View Alarm Push-Button - then Menu: the Message Window will display a "snap shot" of Fatal Alarm conditions at the dryer - Cam Cell, Alarm condition(s) occurred-in Alarm Code Name - then "End of Alarm" Message.

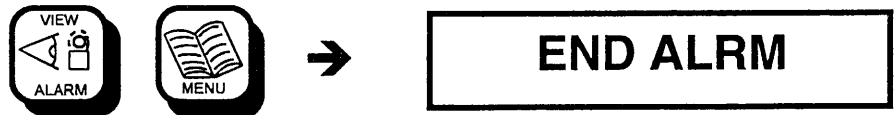

Clearing Alarms:

To clear alarms press the Clear Alarm Push-Button at any time (it is always a good idea to View Alarms before clearing). The Message Window will display



Press  and operation is complete.

Shutdown:

Entering *Function 7* will force machine shutdown. This does not turn the machine off electrically. It simply shuts-down blowers, heaters, and cycling. The unit may be restarted by: Network, Function 8 [STARTUP] or Batch Command. The Message Window will prompt you with **SURE ?** before shutting unit down.

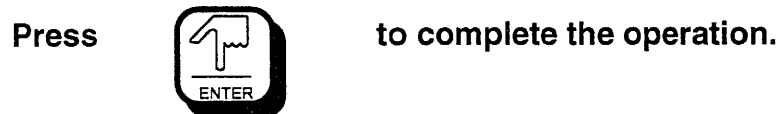

Shutdown:

Entering *Function 8* will force the machine to go through a Restart or Quick-Start Procedure. If unit has been "OFF" for 10 hours or less you will enter Restart - (unit returns to normal operation from its' point of shutdown) — If unit has been "OFF" for 10 hours or more you will enter Quick-Start - (unit begins normal operation from Cam Cell 00 or Cam Cell 50.

PAGE:	SECTION:
01	Welcome to Universal Dynamics
02	1. SAFETY PRECAUTIONS
03	2. INSPECTION UPON ARRIVAL
	<u>UNPACKING</u>
	Parts Included
	hoses
	expansion plug
	cables
	assembly hardware
	<u>SOMETHING MISSING?</u>
	<u>SHIPMENT DAMAGE</u>
	what to do
	hidden damage
04	3. PRINCIPLES OF DRYING
05	4. THEORY OF OPERATION
	4.1 DRYER
06	4.2 HOPPER
07	5. FEATURES
	5.1 STANDARD FEATURES
	5.2 SYSTEM OPTIONS
08	6. MECHANICAL INSTALLATION
	6.1 DRYER
	Mounting Options
	Cooling Coil - Why Needed
	Return Air Cooler
09	Process Air Cooler
	6.2 HOPPER
	Standard Features Non-Insulated Modular Hopper
	Standard Features Insulated Modular Hopper
	Lifting Warning
	Mounting Warning
	Options Available
	Stand
10	Slide Gate
	Flange Adapter
	Drawer Magnet
	Vacuum Take-Off Adapter (VTA)
	6.3 HOSE INSTALLATIONS
11	6.4 EXTERNAL THERMOCOUPLE INSTALLATION
12	7. ELECTRICAL INSTALLATION
	7.1 DANGER: HIGH VOLTAGE
	7.2 FIELD WIRING
	7.3 THERMOCOUPLE
	7.4 DEWPOINT MONITOR
	7.5 SAFETY PRECAUTIONS
14	8. USING THE CONTROLLER
	8.1 CONTROLS AND INDICATORS
	8.2 FUNCTION CODES
16	FUNCTION CODE TREE EXAMPLE

17	FUNCTION CODE TREE
19	0 - [CLR ALRM] Clear Alarm(s)
	1 - [SET TEMP] Set (Process Air) Temperature
20	2 - [D OVERTEMP] Set Delta Over Temperature
	3 - [DEWPOINT] Set Dewpoint Parameters
21	4 - [SCHEDULE] View Command Schedule
23	5 - [MATSAVER] View/Set Material Saver Commands
25	6 - [SQC] View Statistical Quality Control Commands
26	7 - [SHUTDOWN] Shut-Down
27	8 - [STARTUP] Start-Up
	9 - [ALARMS] Configure Dryer Alarm Setting
28	Alarm Library Default Settings
30	10 - [PASSWORD] Enable/Disable and Configure Password Protection
33	11 - [CONFIG] Configure Temperature Scale and Communications Address
35	12 - [DIAGNOSE] Dryer Diagnostics Program
40	8.3 VIEW ALARM PUSHBUTTON
41	8.4 CLEAR ALARM PUSHBUTTON
	8.5 CANCEL PUSHBUTTON
	8.6 SETTING REAL-TIME CLOCK
42	8.7 BATCH COMMANDS
49	8.8 MATERIAL SAVER MODE
52	8.9 DUAL PROCESS HEATER UNITS
53	8.10 DEWPOINT EXTEND
54	9. MAINTENANCE
	9.1 FILTERS
	9.2 BEDS
	Desiccant - Change
55	Desiccant Test
	Heater Testing - Change / Replace
56	9.3 PROCESS HEATER
	9.4 BLOWER
	9.5 DEWPOINT SENSOR
	9.6 PRINTED CIRCUIT BOARDS
57	9.7 CONTACTORS
	9.8 ELECTRICAL DISCONNECT
	9.9 FUSES
	9.10 CHANGEOVER SPOOL VALVE ASSEMBLY
58	9.11 CHANGEOVER SPOOL VALVE MOTOR
	9.12 THERMOCOUPLE SENSOR LOCATIONS
	9.13 OUTPUT DESIGNATIONS
	9.14 INPUT DESIGNATIONS
59	9.15 CABINET COOLING FAN
	9.16 SETTING THE BLOWER PRESSURE SWITCH
61	10. VACUUM CLOSED LOOP CONVEYING
62	AIR FLOW ADJUSTMENT
63	RELATED FUNCTIONS CODES
67	RUN-TIME DIAGNOSTIC FUNCTIONS FOR VCL
	OUTPUT TESTS
68	DUAL VCL DIAGNOSTICS
	DUAL VCL PINOUTS
69	11. MULTI-HOPPER SYSTEM

	11.1 OPTIMIZING AIR FLOW
	11.2 ADJUSTABLE VALVES
	11.3 MANIFOLD
70	11.4 CONFIGURATIONS AVAILABLE
71	12. TROUBLE SHOOTING
76	MAIN BOARD REPLACEMENT
	FIRMWARE REPLACEMENT
	"TIMEKEEPER" REPLACEMENT
77	ENTERING FN SERVICE MODE
78	CHANGING YOUR PASSWORD
79	13. SERVICE INFORMATION
	13.1 WARRANTY PARTS COVERED
	13.2 RETURNING ITEMS FOR SERVICE
	13.3 TELEPHONE SERVICE
	13.4 FIELD SERVICE STAFF

USER'S RESPONSE FORM
MECHANICAL ASSEMBLY DRAWING(S)
ELECTRICAL DRAWING(S)
VENDOR LITERATURE
SAFETY APPENDIX
CONDITIONS OF SALE

WELCOME TO UNIVERSAL DYNAMICS INCORPORATED A COMPANY OF MANN+HUMMEL ProTec

Engineers, management, maintenance personnel and operators are all requesting Universal Dynamics equipment more and more as word of our innovative technology spreads. In the past the majority of our business was with Fortune 500 companies. Now we can offer the same "future" technology to all processors.

If you are interested in auxiliary equipment and value and dependability is important, give UNA-DYN a call at 703.491.2191.

System Engineering Worldwide

UNA-DYN®

1. SAFETY PRECAUTIONS

Customer safety is foremost in our minds at Universal Dynamics Inc.. Building a GREAT performing machine which is SAFE for operators and maintenance personnel is our goal.

To help with this goal certain safety measures are necessary. In the Safety Appendix, located at the rear of the manual, you will notice a section entitled:

CAUTION - WARNING - DANGER

Information is presented to you under these headings throughout the manual and is highlighted so that potentially hazardous areas are called to your attention. Safety precautions specific to an area are presented throughout.

Operator and Maintenance Access:

Maintenance access to the unit is important. For example, changing filters is an easy job which should be performed on a regular schedule, but it may be overlooked if reasonable access to the area is not provided.

Safe, secure access to hopper doors, lids, freestanding filter chambers, dryer towers, etc. must be supplied following O.S.H.A. established standards.

Ladders, access hatches, scaffolds and all maintenance and operator access pathways need to be installed with employee safety in mind.

Please observe our safety precautions; add more safety precautions of your own. If you or your employees have suggestions please let us know. Input from our customers has proven invaluable in the past and will continue to prove invaluable in the future.

DANGER

UNDER NO CIRCUMSTANCES SHOULD EQUIPMENT BE LEFT OPERATING IN AN UNATTENDED FACILITY. OPERATORS SHOULD VISUALLY CHECK UNITS DAILY, AT A MINIMUM, TO INSURE SAFE AND REASONABLE OPERATION AND SHOULD BE PRESENT TO RESPOND TO ANY MALFUNCTIONS IN A TIMELY FASHION.

2. INSPECTION UPON ARRIVAL

Unpacking

Typically the dehumidifier system is shipped assembled in most model sizes and requires no further attention prior to installation.

Hoppers may be partially disassembled for shipment. A perforated spreader cone accompanies each unit and rests on the flange near the bottom of the hopper with the point upward. Small parts, nuts and bolts, hose and hose clamps, etc. are typically shipped inside the hopper and must be removed to complete installation.

Parts Included

A Packing List is included with the equipment listing all parts included in your order. The Packing List also will indicate if any parts were back-ordered and not shipped. Examples of items identified on the Packing List in addition to the dryer and hopper could be:

- Hoses (2 types available)
 1. *Hi-Temp Red Silicone - typically used for connection of dryer inlet to hopper outlet.*
 2. *Insulated Hi-Temp Hose - typically used for connection of dryer outlet to hopper inlet.*
- Hose Clamps
- Expansion Plugs for Hopper drain-out.
- Cables for hookup of Communications (if ordered).
- Hardware (nuts, washers and bolts) necessary to assemble sections of hopper, hopper stand, dryer components, etc.

Something Missing?

First check the Packing List included with your order. (While every attempt is made to insure that all parts are available when your unit is shipped we have vendor delivery problems too) The missing part may have been back-ordered.

If this is the case, the needed part will be forwarded to you as soon as possible.

But wait, the Packing List says we shipped it. Your dock crew insists it never came in. The following is a suggested checklist before calling the factory:

- Look yourself (enough said).
- Open ALL boxes (what looks like filler may have 75 nuts and bolts inside).
- Look inside the Hopper one more time.
- Look in the dryer cabinet.

Still not around?

Contact the factory in Woodbridge, VA. The main factory telephone number is **703.491.2191**. The receptionist will connect you with the appropriate department. OR, if you wish, the FAX number is **703.490.7001**.

Shipment Damage

Visible shipping damage must be reported to the carrier immediately. **It is the carriers' responsibility to insure that equipment is delivered undamaged.**

Hidden damage should be reported to the carrier as soon as discovered. It is imperative that the shipment be checked as soon as it arrives. A representative for the carrier will come to your plant and inspect damage.

The carrier is responsible for damage caused during shipment. Please explore a satisfactory solution with the carrier. Universal Dynamics Corporation uses major trucking companies who make every attempt to deliver your equipment to you quickly, completely and with NO damage. In the event of a problem the carrier will work with you to eliminate the problem as quickly as possible.

3. PRINCIPLES OF DRYING

In order to understand the operation of Una-Dyn dehumidifiers, it may first be necessary to review the following basic concepts about Humidity.

What is humidity? It is the water vapor present in the air. The actual amount of moisture in the air is called Absolute Humidity. It is measured in grains per cubic foot of air. The type of humidity usually referred to in weather reports is called Relative Humidity. This is the amount of moisture in the air compared to the amount the air could hold. When the air holds as much moisture as it possibly can, then the relative humidity is 100%. If it contains only half the possible amount, the relative humidity is 50% and so on.

How much moisture can the air hold? When air is warmed it expands and can hold more moisture. For example: at 32° F. (0 degrees C.) it can hold about 2 grains of moisture; at 70° F. (20° C.) about 8 grains, and 100° F. (36° C.) about 20 grains.

Una-Dyn deals with another measure of moisture measurement called Dewpoint. Dewpoint is the temperature at which condensation of water vapor in the air takes place (a saturated condition at a given temperature). Air that is -40 dewpoint at 100° F. then heated to 400° F. will still be at a -40 dewpoint. Dewpoint therefore is an absolute moisture measurement - not relative and not temperature dependent.

Dehumidification is the process by which moisture is removed from the air. The method used is called adsorption. With this process, the air to be dried is passed through a material called desiccant, which acts like a water magnet adsorbing the moisture from the air, while letting the air itself pass through. The process of dehumidification lowers the air's dewpoint. The air is then heated to reduce its relative humidity. The sum of these efforts results in hot, dry air with an increased "thirst", or capacity for

moisture.

In Una-Dyn dehumidifying hopper dryers, air from the dehumidifier is heated by the process heater and circulated through a hopper full of material, which gradually gives off some of its moisture to the surrounding air. The moisture thus removed from the plastic is carried back to the dehumidifier, where it is adsorbed by the desiccant and held there.

Obviously, at some point it becomes necessary to remove the accumulated moisture from the desiccant. This process is called regeneration, and is achieved by heating the desiccant to a temperature high enough to drive off the adsorbed water. Regeneration temperatures are in a range of 500 to 625° Fahrenheit (250 to 316° Centigrade). The desiccant bed should be cooled to usable temperatures before it can again be placed in service, adsorbing moisture.

In a typical dehumidifier there are two beds of desiccant, one of which is being reactivated then cooled, while the other one is drying the process air. The switching of the air stream from one bed to the other is automatically controlled by the microprocessor controller, so that from the user's point of view, the dehumidifier is producing a constant stream of hot, dry air.

4. THEORY OF OPERATION

4.1 Dryer:

The dehumidifying unit consists of: two desiccant beds and two bed (regeneration) heaters. The desiccant is stored directly above the regeneration heaters separated by perforated metal. Air is directed through the desiccant beds and past the bed heaters through a "spool valve". Only one blower is used to supply both **process** and **regeneration air**.

Referring to the "System Diagram" at right, you can see how the air passes through the desiccant bed and is dried by contact with the desiccant. The air that leaves the desiccant bed is then separated into two air streams. The majority of the air enters the process-heater and is elevated to process setpoint before entering the hopper. The air is blown through the spreader cone, and up through the plastic material. Moisture in the plastic is transferred to the air by a combination of heat and the vapor pressure differential between the plastic pellets and the dry air. The remaining air enters the regenerating bedheater and up through the regenerating desiccant bed and exhausts through the spool valve to atmosphere.

NOTE: The amount of regeneration air is determined by the amount of back-pressure against the blower. The unit has been designed to run at maximum efficiency when the hopper is full. Less material in the hopper will produce less back-pressure, therefore, changing regeneration air flow.

Before the desiccant bed reaches a point of saturation, the microprocessor sequences the unit to change the desiccant bed from "process" to "regeneration". This is accomplished by the valve "switching" the air direction so that a bed which has previously been reactivated is now used for process.

During the regeneration cycle, the desiccant is

raised to regeneration temperatures by the bedheater. At this elevated temperature, the desiccant releases its adsorbed moisture to be carried off by the reactivation airflow to ambient. Once the desiccant regeneration/ reactivation is complete, the bedheater automatically shuts off. After the desiccant is dynamically cooled to a usable temperature, the controller automatically returns the desiccant bed to the process cycle.

The two cycles, process air to the hopper and regeneration air to the beds, are a continuous cycle.

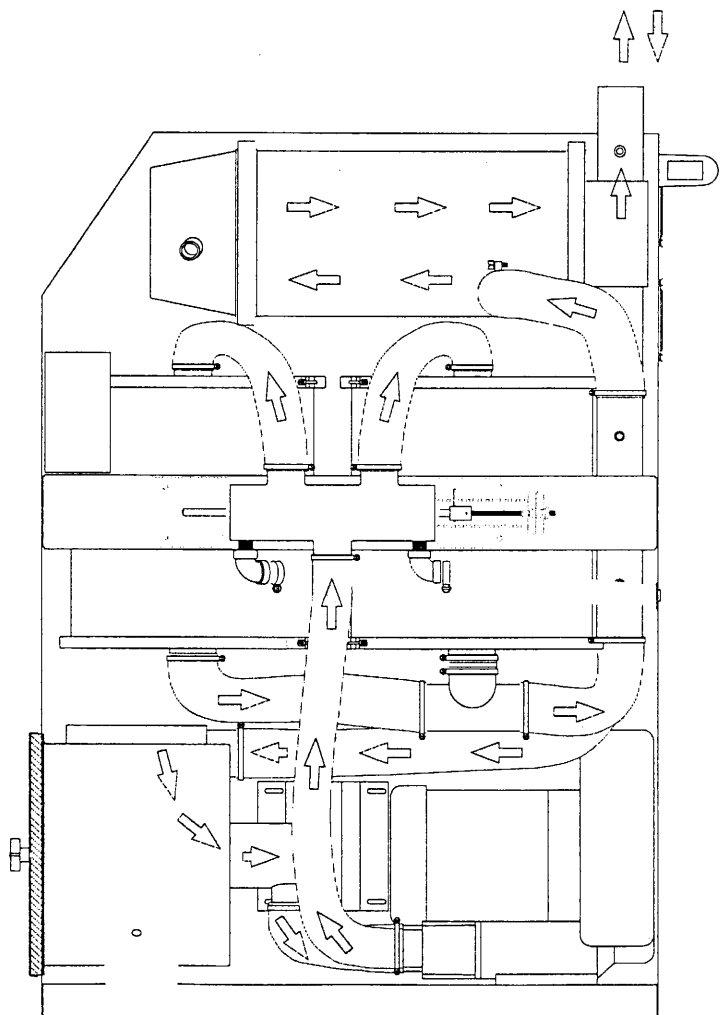

4.2 Hopper:

Standard features of the *Una-Dyn Non-Insulated Modular Design* hopper (25# to 300#) include:

- Stainless steel spreader cone for quick cleanup
- Strap clamps connecting modular units
- Full 360 degree orientation capability of inlet and outlet air ducts through rotation of modular sections.
- Hinged clean-out door on 100 lbs. and above hoppers for easy maintenance
- Sight glass(es)
- Air tight design for super efficiency

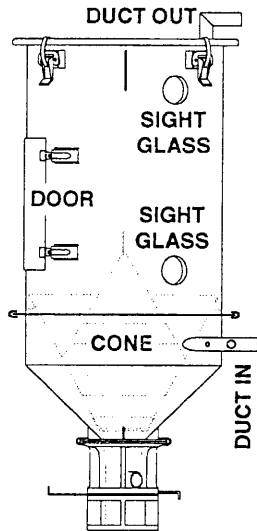

Standard features of the *Una-Dyn Modular Design* hopper (50# to 400#) include:

- Stainless steel contact surfaces
- Stainless steel spreader cone for quick cleanup
- Quick action strap clamps connecting modular units
- Full 360 degree orientation capability of inlet and outlet air ducts through rotation of modular sections.
- Hinged clean-out door for easy maintenance (100# and Larger)
- Easy to view, optically clear, sight glasses
- Air tight design for super efficiency
- Integral lifting lugs.

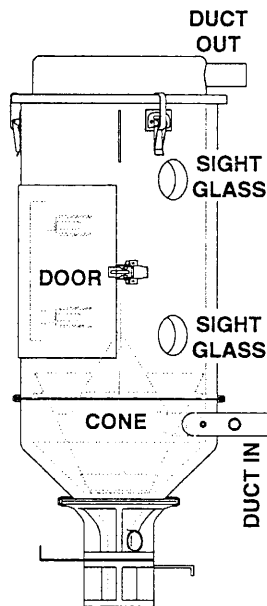

NOTE: Hoppers may be custom designed for mounting directly over the throat of the processing machine or stand mounted on the

floor.

Hoppers may be partially disassembled for shipment. A perforated metal spreader cone accompanies each unit and will rest, after setup, on the flange at the top of the conical section of the hopper with the point upward. Small parts, nuts and bolts, hose and hose clamps, etc. are typically shipped inside the hopper and must be removed and installed to complete installation.

WARNING

LIFTING LUGS MOUNTED ON THE LID ARE TO BE USED AS A COMPLETE SET. STRAP ASSISTED LIFTING IS MANDATORY TO MAINTAIN BALANCED LOAD AT LIFTING LUGS. FAILURE TO UTILIZE ALL LIFTING LUGS WHEN LIFTING THE HOPPER WILL RESULT IN UNBALANCED LOAD AND LIFTING LUG FAILURE. SAFETY CHAINS ARE RECOMMENDED. LIFTING LUGS ARE NOT TO BE USED TO LIFT HOPPERS WITH MATERIAL OR HOPPER AND MACHINE COMBINATIONS.

Clean the hopper and spreader cone thoroughly. Wipe away all dirt, dust, oil, or rust that may have accumulated during transit.

Mount the drying hopper in a vertical position. If machine mounted, secure the hopper with bolts at the bottom of the flange and with guide wires or braces to INSURE safe mounting on the throat of the machine.

WARNING

WHEN MOUNTING THE DRYING HOPPER ON THE PRESS THROAT, ADEQUATE SUPPORT MUST BE PROVIDED.

WHEN THE DRYING HOPPER IS STAND MOUNTED, FASTEN THE FLOOR PADS SECURELY TO THE MOUNTING SURFACE.

5. FEATURES

The F/N controller makes all the decisions necessary to dry material. All you need do is set the drying temperature and it will do the rest.

If something goes wrong, the unit will try to fix itself, and only if it cannot will it declare an alarm and identify the problem with an alarm code displayed in the Message Window.

5.1 Standard System Features:

- Fully Automatic Desiccant Regeneration
- Low Energy Single Blower Design
- Overtemperature Protection
- Easy Accessibility for Maintenance
- Cartridge Type Return Air Filter
- Hi-Temp Insulated Hose for air temperatures up to 400° Fahrenheit (204° Centigrade). For air delivery to hopper
- Red Silicone Hose for air return to dryer
- Non-Insulated Hopper
- User Friendly Display
- Touch Pad Operator Controls
- View and Clear Alarms Push Buttons
- Alarm Annunciator Output
- Automatic Alarm Recovery on selected alarms
- Dewpoint Monitor and Display
- 7 Day Clock
- Ability to Control 2 Hopper Mounted Process Heaters
- Continuous Dry Air Stream
- SPI Protocol
- NO Compressed Air Required*

5.2 System Options:

- Plasticizer Filter / Cooling Coil
- Pre-Cooling Coil; a high process temperature operation significantly increases the return air temperature back into the desiccant bed. A precooling coil can be used to lower the return air temperature to 125° Fahrenheit (50° Centigrade)

Note: Return air to the dryer should not fall

below 95° Fahrenheit.

- Floor Mounting Package with wheels
- Insulated Hopper
- Hopper Mounting Kit
- Additional Hopper with Hopper Mounted Process Heater and Control Input (Not Available with VCL Conveying Package)
- Hopper Mounted Drawer Magnet
- VCL (Vacuum Closed Loop) Conveying Package (Not Available with Dual Process Heater Units)
- Material Level High Indication Device
- Material Level Low Indication Device

6. MECHANICAL INSTALLATION

6.1 Dryer:

Locate the dehumidifier as near the hopper as possible. Standard lengths of hose provided are 12 feet for the silicone hose and 10 feet for insulated hose; longer runs of hose than this may handicap the dryers performance. If your setup mandates a longer run of hose please contact the factory.

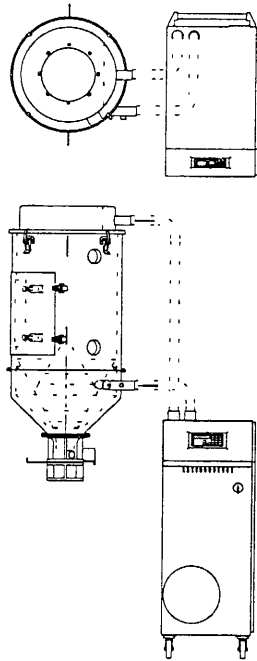

The dryer may also be mounted in the following fashions:

Floor Mounting - which includes hose, clamps and the portable package necessary. Install portable package, hose and clamps as illustrated in Section 6.3.

Hopper Mounting - which includes hose, clamps and mounting bracket necessary. The mounting bracket is already attached to the hopper. Install hardware, hose and clamps as illustrated in Section 6.3.

WARNING

DRYER MUST BE MOUNTED IN UPRIGHT POSITION WITH INLET AND OUTLET CONNECTIONS ON TOP OF UNIT. MERCURY CONTACTORS IN CONTROL BOX WILL NOT WORK OTHERWISE.

Cooling Coils:

Return air from the hopper to the dryer must be cooled to temperatures below the process temperature. The following graph provided for reference only illustrates how important it is to lower the temperature of return airflow from the hopper.

Given air at 200° F. with a -40 dewpoint, the desiccant will only adsorb 4 percent moisture. That same air cooled to 100° F. (36.2° C.) will allow the desiccant to adsorb 14 percent moisture. At 100° F. the desiccant is **3 1/2** times more efficient.

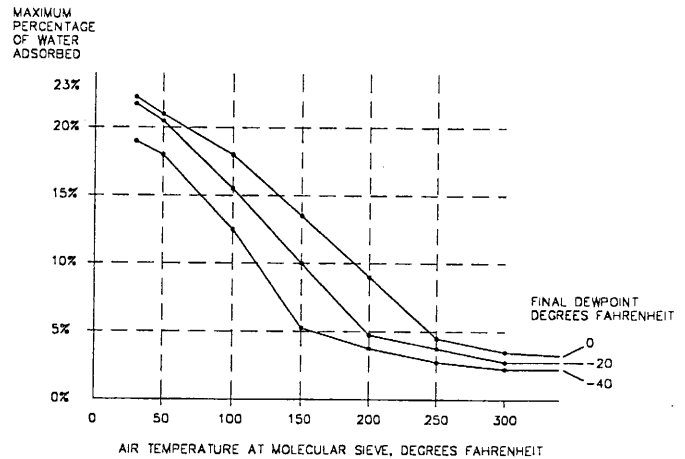

Return Air Cooling Coil

(installed in place of the air filter lid) -

High temperature drying application involving hopper inlet temperatures greater than 250° Fahrenheit (121° Centigrade) requires the

installation of a cooling coil in the return air line. The return air temperature to the dryer should be regulated to approximately 125° F. (50° C.)

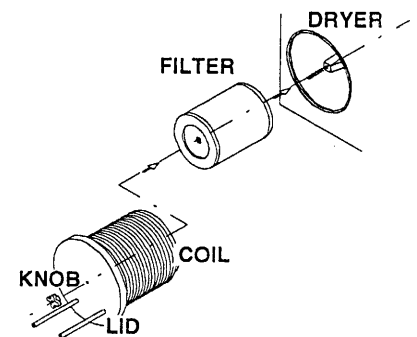

Water should be supplied at a rate of 4 to 8 gallons per minute and at a temperature below 90° Fahrenheit. The flow of water through the coil may be either continuous or regulated by a temperature control valve.

CAUTION

"CHILLED" WATER SHOULD NOT BE USED. TOO LOW A RETURN AIR TEMPERATURE WILL AFFECT DRYER PERFORMANCE AND MAY CAUSE AN UNDERTEMPERATURE CONDITION.

CAUTION

WHEN USING MATERIAL SAVER IN CONJUNCTION WITH A RETURN AIR COOLING COIL THE THERMOCOUPLE MUST BE PLACED AT THE HOPPER AIR OUTLET IN ORDER FOR CORRECT OPERATION.

Process Air Cooler

Process Air Cooling Coil (Install in-line between process-heater outlet and hopper air inlet OR between dryer air outlet and process-heater inlet on Hopper Mounted Cooler units) - Low temperature drying application involving hopper inlet temperatures less than 170 degrees Fahrenheit (74 degrees Centigrade) typically requires the installation of a cooling coil on the process air line going to the hopper.

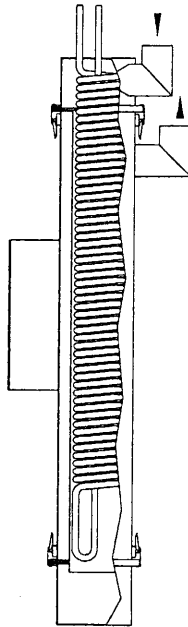

Water should be supplied at a rate of 4 to 8 gallons per minute and at a temperature below 90° Fahrenheit. The flow of water through the coil may be either continuous or regulated by a temperature control valve.

CAUTION

IF PROCESS TEMPERATURES ARE TO BE IN THE 250 TO 300° FAHRENHEIT (121 TO 148° CENTIGRADE) RANGE INSULATED SUPPLY HOSE MUST BE USED AND RED SILICONE HOSE MUST BE USED FOR RETURN AIR LINES

6.2 Hopper:

Hoppers may be partially disassembled for shipment. A perforated metal spreader cone accompanies each unit and will rest, after setup, on the flange at the top of the conical section of the hopper with the point upward. Small parts, nuts and bolts, hose and hose clamps, etc. are

typically shipped inside the hopper and must be removed and installed to complete installation.

WARNING

LIFTING LUGS MOUNTED ARE TO BE USED AS A COMPLETE SET. STRAP ASSISTED LIFTING IS MANDATORY TO MAINTAIN BALANCED LOAD AT LIFTING LUGS. FAILURE TO UTILIZE ALL LIFTING LUGS WHEN LIFTING THE HOPPER WILL RESULT IN UNBALANCED LOAD AND LIFTING LUG FAILURE. SAFETY CHAINS ARE RECOMMENDED.

Clean the hopper and spreader cone thoroughly. Wipe away all dirt, dust, oil, or rust that may have accumulated during transit.

Mount the drying hopper in a vertical position. If machine mounted, secure the hopper with bolts at the bottom of the flange and with guide wires or braces to INSURE safe mounting on the throat of the machine.

WARNING

WHEN MOUNTING THE DRYING HOPPER ON THE PRESS THROAT, ADEQUATE SUPPORT MUST BE PROVIDED.

WHEN THE DRYING HOPPER IS STAND MOUNTED, FASTEN THE FLOOR PADS SECURELY TO THE MOUNTING SURFACE.

Hopper Stand:

If stand mounted, insure that all assembly hardware is snug and secure before mounting hopper to stand. A hopper stand can be provided in various heights - for example:

- 52 inches tall from the floor to the bottom of the stand.
- 38 inches tall from the floor to the bottom of the stand.
- 22 inches tall from the floor to the bottom of the stand.

Slide Gate:

Slide Gate - The standard drying hopper is supplied with a slide gate for shutting off the flow of dried plastic from the throat of the drying hopper.

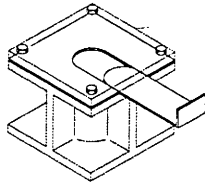

Particle size, bulk density and uniformity of your particular material affect the adjustment - hence if you change material you may find it necessary to change the setting.

Flange Adapter:

Flange Adapter - If the Drying Hopper is ordered with a specific bolt pattern or throat opening that does not match the standard four bolt hopper bottom, a cast or fabricated adapter will be used. This adapter would only be used on hoppers without the magnet option. The magnet housing is used as the adapter when it is ordered.

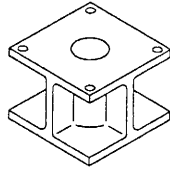

6.3 Hose Installation:

Standard Installation (not utilizing a mounting kit):

Install hose from dry air outlet (process heater outlet) on dehumidifier to the hopper air inlet.

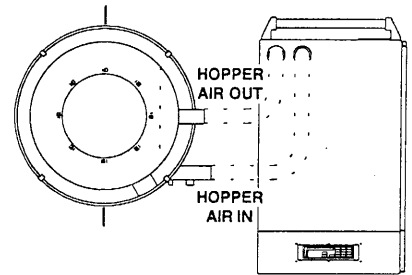

Connect hose from the hopper air outlet to the process air inlet at the dehumidifier.

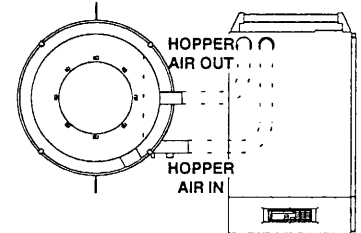

Drawer Magnet:

Drawer Magnet - The device is located directly below the hopper's feed throat. A pullout drawer assembly can be extracted from the magnet's housing for removal of ferrous metals trapped by the elements of the magnet.

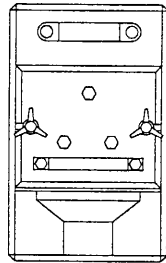

Installation utilizing the Floor Mounting kit:

Install hose from dry air outlet (process heater outlet) on dehumidifier to the hopper air inlet.

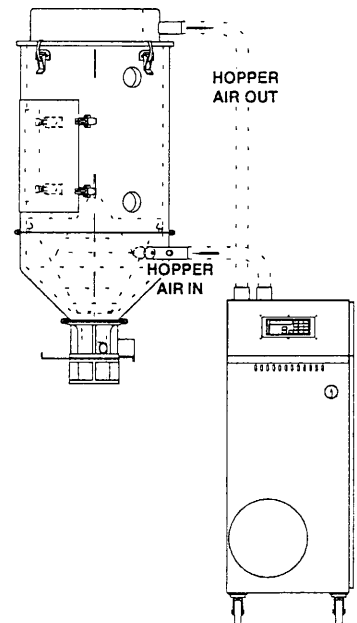

Connect hose from the hopper air outlet to the process air inlet at the dehumidifier.

Vacuum Takeoff Adapter:

Vacuum Takeoff Adapter (VTA) - The VTA is attached to the bottom of the hopper and serves as a material pickup point from the hopper to a vacuum loading station.

For maximum material flow thru the VTA adjust the air flow by sliding the collar on the pickup tube.

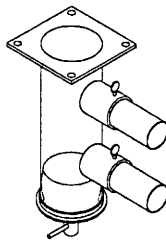

Sliding the collar back and forth will increase or decrease the amount of air introduced into the material line. Adjust for maximum material flow that does not allow slugging of material line.

6.4 External Thermocouple Cable/Probe Assembly:

The probe assembly is shipped to you with the probe inserted into the process heater outlet as a standard. If the probe is externally mounted it should be installed in the process air inlet of the hopper.

Note that probe tip should not touch the tube stub wall or false temperature readings may result.

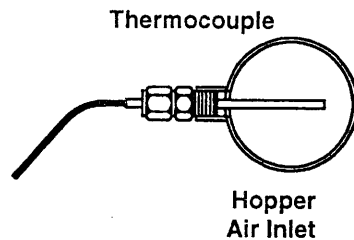

If you wish to move the thermocouple to the hopper:

1. Turn "off" and "Lockout" any electrical connections and/or supply power.
2. Open dryer cabinet door.
3. Remove thermocouple probe from process heater coupling by loosening brass connector.
4. Install a 1/8" pipe plug into opening left at process heater by the removal of the probe and coupling.
5. Carefully pull cable through "knockout" in side of dryer cabinet. Tighten mechanical connector at "knockout".
6. Close dryer cabinet door.
7. Install thermocouple into hopper air inlet (illustration at right).

Thermocouple probes should be checked for proper entry into the airstream. Couplings should be snug, but not overly tight. Too much pressure from the coupling on the probe could cause a failure.

CAUTION

WHEN USING MATERIAL SAVER IN CONJUNCTION WITH A RETURN AIR COOLING COIL THE THERMOCOUPLE MUST BE PLACED AT THE HOPPER AIR OUTLET IN ORDER FOR CORRECT OPERATION.

7. ELECTRICAL INSTALLATION

7.1

DANGER: HIGH VOLTAGE

OBSERVE "LOCKOUT/TAGOUT" REGULATION FROM O.S.H.A. - FURTHER INFORMATION INCLUDED ON SUGGESTED COMPLIANCE PROCEDURES FOUND IN THE SAFETY APPENDIX FOUND AT THE FRONT OF THE MANUAL.

TURN OFF ALL ELECTRICAL POWER TO THE FEEDING CIRCUIT BEFORE MAKING ANY ELECTRICAL CONNECTIONS.

BEFORE WORKING ON ANY MACHINERY ELECTRICAL CIRCUITS, TURN THE MACHINE MAIN DISCONNECT "OFF" AND LOCK IT.

IF, FOR ANY REASON, THE ELECTRICAL WORK CANNOT BE COMPLETED AND THE MACHINE MUST BE LEFT UNATTENDED ALWAYS LOCK THE MAIN DISCONNECT SWITCH AND CLOSE THE DOOR.

7.2 Field Wiring:

Your dryer is complete with power cable ready for installation.

A wall mounted fused disconnect or circuit breaker MUST be provided for disconnecting the machine from the power supply.

Customer field wiring is identified on the electrical drawing supplied with the manual. Additionally, control box and optional equipment connections are identified on the electrical drawing.

Connect electric power as indicated on the machine nameplate. Wire size can be determined from KVA rating also found on the machine nameplate.

National Electric Code (N.E.C.) Book should be consulted for wire gauges. Ambient temperatures as well as full load KVA must be a consideration when selecting wire gauges for installation.

7.3 Thermocouple:

The Thermocouple is pre-wired and located at the process air outlet and as such typically requires no installation (except on externally mounted units designed to accommodate customer requested options).

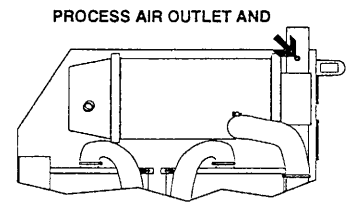

7.4 Dewpoint Monitor:

The dewpoint monitor is pre-mounted to the control panel and as such requires no installation.

7.5 Safety Precautions:

Customer safety is foremost in our minds at Universal Dynamics Corporation. Building a GREAT performing machine which is SAFE for operators and maintenance personnel is our goal.

To help with this goal certain safety measures are necessary. In the Safety Appendix you should have noticed a section entitled:

CAUTION - WARNING - DANGER

Information is presented to you under these headings throughout the manual and is highlighted so that potentially hazardous areas are called to your attention. Safety precautions specific to an area are presented throughout.

Operator and Maintenance Access:

Safe, secure access to hopper doors, lids, freestanding filter chambers, dryer towers, etc. must be supplied following O.S.H.A. established standards.

Ladders, access hatches, scaffolds and all maintenance and operator access pathways need to be installed with employee safety in mind.

Please observe our safety precautions. Add more of your own. If you or your employees have suggestions please let us know. Input from our customers has proven invaluable in the past and will continue to prove invaluable in the future.

DANGER

UNDER NO CIRCUMSTANCES SHOULD A DRYER BE LEFT RUNNING IN AN UNATTENDED FACILITY. OPERATORS SHOULD VISUALLY CHECK THE DRYER DAILY, AT A MINIMUM, TO INSURE SAFE AND REASONABLE OPERATION AND SHOULD BE PRESENT TO RESPOND TO ANY MALFUNCTIONS IN A TIMELY FASHION.

8. USING THE CONTROLLER

8.1 Controls and Indicators:

The FN Controller is microprocessor based. Operator controls for the unit are located on the dryer front panel. The display panel features: An eight (8) digit numerical display (the Message Window), and seven (7) additional L.E.D. indicator lights.

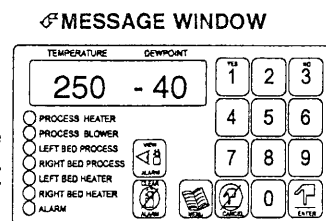

- Process Heater
- Process Blower
- Left Bed Process
- Right Bed Process
- Left Bed Heater
- Right Bed Heater
- Alarm

****Dewpoint display and****Process Temperature are normally displayed in the Message Window. Anytime the controller detects a **fatal alarm condition**, the Alarm LED will flash and the Alarm Name will flash in the Message Window. All operator requests are entered using Functions Codes. **Function Code Tree is detailed on page 17.**

****Every 3 minutes the Message Window will display the current Process Air Setpoint [T1 = 225 for example]. An "X" is displayed between the Temperature and Dewpoint digits during Changeover. If Material Saver Setpoint is active, an "M" will appear next to the Temperature, and "MS1=XXX" will be displayed every 3 minutes. See "Function 5" for further information about Material Saver.**

8.2 Function Codes:

Selecting Function Codes may be done in any of four ways:

1. Use the Menu key to *scroll forwards* to your desired function. This is illustrated in the example at right.

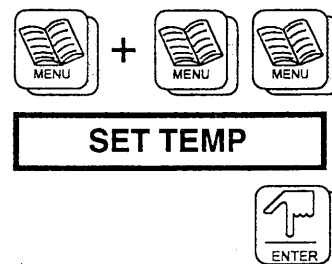

You press Menu the first time to enter into the Function Code Tree; then each press of Menu moves you through the listing of that particular function code tree "branch". When you reach the desired Function, press the Enter key. *Note that a full Function Code Tree can be found on Page 19.*

In the example at right you have moved to **Function Number 1: Set Process Temperature [SET TEMP]**. *Even though you pressed Menu 3 times - the first time you pressed the key was simply to allow you to enter the Function Code Tree.*

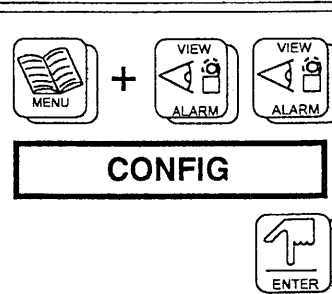

2. Use the Menu key then the View Alarm key to *scroll backwards* to your desired function. This is illustrated at right.

You press Menu the first time to enter into the Function Code Tree; then each press of View Alarm moves you backwards through the listing of function codes. When you reach the desired Function, press the Enter key.

In the example at right you have moved to **Function Number 11: Configure Dryer [CONFIG]**. *Remember - the first time you pressed the Menu key was to allow you to enter the Function Code Tree.*

3. Enter the Function Code desired using the Numbered keys, then press the Enter key. This will allow you into the Function Code Tree directly.

At this point use the Menu key to *scroll* to your desired Function within this "tree" level. This is illustrated at right.

When you reach the desired Function, press the Enter key.

In the example at right you have moved directly to **Function Number 4: View Command Schedule [SCHEDULE]**.

At this point you will *scroll* to the desired Function. In our example you press the Menu key once to: **View Batch Commands [VW BATCH]**.

Press the Enter key and you may *scroll* through the commands under this heading using the Menu key.

4. Enter the individual Function Code desired directly using the Numbered keys. This is illustrated at right where you key-in **Function 42: View Batch Commands [VW BATCH]**.

At this point press the Enter key and you may *scroll* through the commands under this heading using the Menu key.

Method Number 4 is the quickest HOWEVER, until you feel comfortable with the keypad and using Function Codes you may wish to use **Methods 1, 2 or 3**.

Returning to normal operation or previous "tree" level:

1. Each press of the Cancel key "unwinds" you through one tree level**

2. To return to the previous "tree" level press the Cancel key once.

**Several presses of the Cancel key may be necessary. Please refer to page 44 for further information.

Page 17 shows an individual Function Code Level with its associated Function Code Branches.

Page 19 shows the Function Code Tree. Note that all tree "levels" are not detailed. You will be directed to the appropriate page in the manual for further information where necessary.

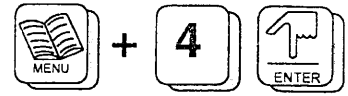

The following example may offer some insights into "tree levels" and "branches".

In our example we will look specifically at Function Number 6 [SQC] View Statistical Quality Control.

When the Message Window is displaying the *Process Air Temperature and system Dewpoint* information, press the Menu key **eight** times to gain access into SQC (remember the first press of the Menu key is to gain access to the Function Code Tree and Function Codes begin with 0 for Clear Alarm).

You may also directly enter by using Function Code 6.

When the display reads: SQC press the Enter key and you are ready to move through its associated "branches".

Each press of the Menu key allows you to move through the "branches" under the main heading SQC.

Remember: You may also directly enter any branch of the Function Code Tree by using its associated Function Code Number.

To leave a "branch" of the Function Code Tree you may press the Cancel key. To return to the main display (Process Air Temperature and system Dewpoint) several presses of the Cancel key may be required. In our example two presses of the Cancel key will return us to the Process Air Temperature and Dewpoint display.

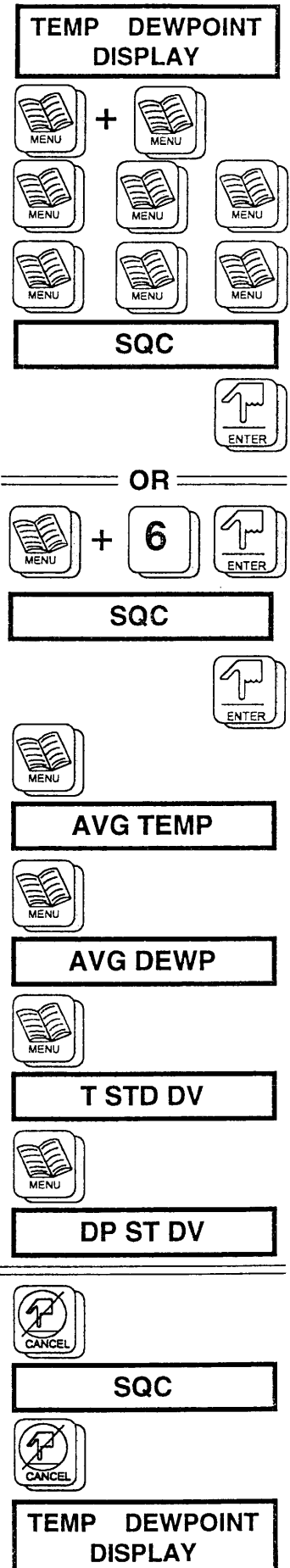
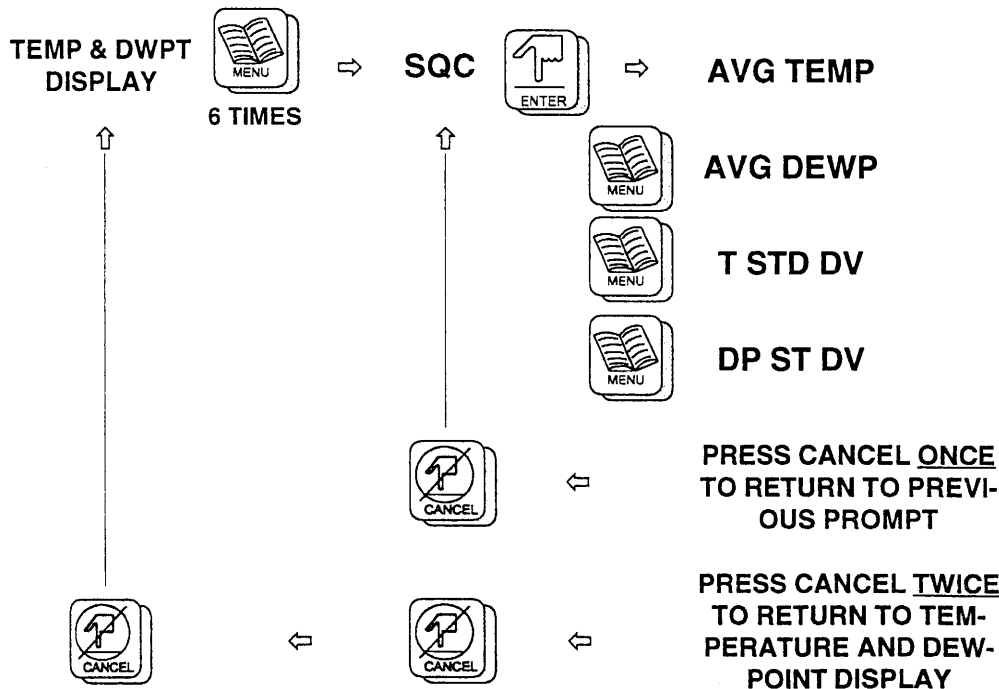

Password Level 0 Protected

Function 0: CLR ALARM [Clear Alarms]

Allows operators to clear any alarms which may be present in the system.

It is always a good idea to "View Alarms" before clearing. This may possibly allow you to take preventive action to avoid the alarm in the future.

Note: There is also a separate push-button for this function.

To Review — Related Function Codes at this "tree level":

NONE

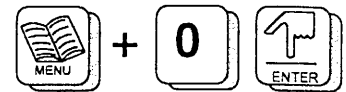

CLR ALRM

Password 0
Protected



TO RETURN TO PREVIOUS
"TREE" PROMPT, PRESS:



Password Level 1 Protected

Function 1: SET TEMP [Set Process Temperature]

Sets Process Air Temperature.

Note: Units built with two Process Heaters require special commands. Refer to Section 8.10 for further information.

Select Function 1. After pressing the Enter key the display will show you the current Process Air Temperature. In the example at right: *XXX is the current Setpoint temperature*

Enter in the desired temperature; in our example we will use 32° F.

The Message Window reflects the changes as they are entered.

After keying in the selection, press the Enter key to save the new value.

Note: If you are using 2 process heaters - after pressing ENTER the display will prompt you for the Second Setpoint entry. Refer to Section 8.9 for further information on dual process heater units.

To Review — Related Function Codes at this "tree level":

NONE

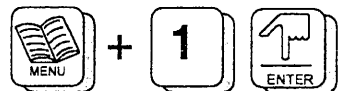

SET TEMP

Password 1
Protected



T 1 = XXX

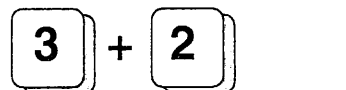

T 1 = 032



TO RETURN TO PREVIOUS
"TREE" PROMPT, PRESS:



Password Level 2 Protected

Function 2: Δ OVERTMP [Set Delta Over Temperature]

Sets the Delta** Overtemperature Alarm Setpoint.

**Delta Overtemperature Alarm Setpoint is the allowable number of degrees the detected process air temperature can exceed the operator entered setpoint before the controller declares an alarm. When the detected process air temperature drops to the original Setpoint the dryer will automatically return to operation.

After pressing the Enter key the display will ask you for your desired Delta Overtemperature Setpoint. In the example at right: *XXX is the current Delta Overtemperature Setpoint temperature*

Enter in the desired temperature; in our example we will use 50° F.

After keying in the selection, press the Enter key to save the new value.

For example: this indicates that with a Setpoint of 300° F. the dryer will issue an *overtemperature alarm* when the dryer detects a process air temperature of 350° F. and return to operation when the Process Air Temperature drops to 300° F.

***To Review — Related Function Codes at this "tree level":
NONE***

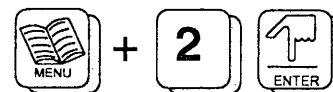

Password 2
Protected

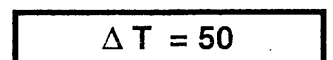
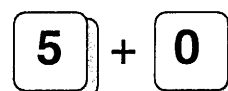
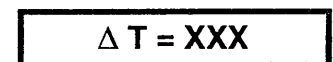

TO RETURN TO MAIN
DISPLAY, PRESS:



Password Level 0 Protected

Function 3: DEWPOINT [Set Dewpoint Parameters]

The Dewpoint Tree Level consists of two commands which enhance operator control of the dryer.

These Functions include:

•**31: DEW TRIG [Set Dewpoint Trigger] Password 2 Protected - Example on page 27.**

•**32: DP EXTND [Set Dewpoint Extend ON or OFF] Password 2 Protected - See Section 8.10 for further information.**

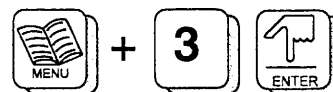

Password 0
Protected



Password 2
Protected



After pressing the Enter key the display shows you the next tree level:
Function 31: Set Dewpoint Trigger [DEW TRIG] .

Dewpoint Trigger is the user entered value above which the controller declares an alarm.

Press the Enter key again and the display will show the current Dewpoint Trigger Setpoint; in our example *XXX is the current Dewpoint Alarm Trigger Setpoint.*

Enter in the desired Dewpoint Trigger; in our example we will use -10° F. Any value above this, for example -8° F would trigger an alarm

After keying in the selection, press the Enter key to save the new value.

To Review — Related Function Codes at this "tree level":

- 31 [DEW TRIG] Set Dewpoint Trigger
- 32 [DP EXTND] Set Dewpoint Extend:

See Section 8.10 for complete information on Dewpoint Extend.

Password Level 0 Protected

Function 4: SCHEDULE [Enter into Commands Function Schedule]

The Commands Function Schedule consists of a number of commands which enhance operator control of the dryer allowing you to "program" the Start-Up, Shut-Down and Drying Temperature based on Date and Time.

These Functions include:

- 41: **VIEW CLK [View Real-Time Clock]** Password 0 Protected - Example follows.
- 42: **VW BATCH [View Batch Commands]** Password 0 Protected - See Section 8.7 for further information on how to View Batch Commands.
- 43: **SETBATCH [Set Temporary and Permanent Batch Commands]** Password 1 Protected - See Section 8.7 for further information on how to Set Batch Commands.
- 44: **DELBATCH [Delete Temporary and Permanent Batch Commands]** Password 1 Protected - See Section 8.7 for further information on how to Delete Batch Commands.
- 45: **SET CLOCK [Set Real-Time Clock]** Password 1 Protected - See Section 8.6 for further information on how to set the Real-Time Clock.

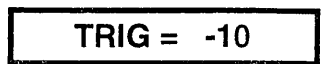
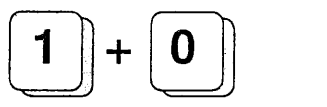
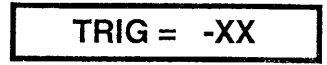

TO RETURN TO PREVIOUS "TREE" PROMPT, PRESS:



TO RETURN TO MAIN DISPLAY, PRESS:

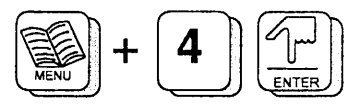
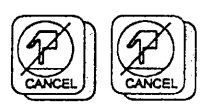

Password 0 Protected



To further enhance the concept that there are several ways to access the Function Code Tree we will gain entry into **Function 41, View Clock**, via Function 4 and scrolling. Then directly using Function 41.

Example 1: Viewing the Clock via Function 4: SCHEDULE

Enter Function 4 and press the Enter key.

Press the Enter key again to display the first command under the *Schedule* heading. This happens to be our desired location: *View Clock*

At this point you may press the Enter key and the information is displayed in the Message Window.

The first three digits display the day of the week:

The next two digits are the hour:

00 = 12 a.m.	01 = 1 a.m.	02 = 2 a.m.
03 = 3 a.m.	04 = 4 a.m.	05 = 5 a.m.
06 = 6 a.m.	07 = 7 a.m.	08 = 8 a.m.
09 = 9 a.m.	10 = 10 a.m.	11 = 11 a.m.
12 = noon	13 = 1 p.m.	14 = 2 p.m.
15 = 3 p.m.	16 = 4 p.m.	17 = 5 p.m.
18 = 6 p.m.	19 = 7 p.m.	20 = 8 p.m.
21 = 9 p.m.	22 = 10 p.m.	23 = 11 p.m.

The last two digits are the minute:

00 to 59

(See Section 8.6 "Set Clock" for information on setting the real time clock.)



SCHEDULE

Password 0
Protected



VIEW CLK

Password 0
Protected



DAY MINUTE
| |
MON 0630
|
HOUR

THIS EXAMPLE INDICATES THAT IT IS MONDAY, 6:30 A.M.

Example 2: Viewing the Clock via Function 41: VIEW CLOCK

Enter Function 41 and press the Enter key.

Press the Enter key again to display the information in the Message Window. For example: Tuesday, 3:42 p.m.



VIEW CLK



TUE 1542



To Review — Related Function Codes at this "tree level":

- 41 [VIEW CLK] View Real-Time Clock
- 42 [VW BATCH] View Batch Commands
- 43 [SETBATCH] Set Batch Commands
- 44 [DELBATCH] Delete Batch Commands
- 45 [SETCLOCK] Set Real-Time Clock

Refer to Section 8.7 for complete information on Batch Commands

TO RETURN TO PREVIOUS "TREE" PROMPT, PRESS:



TO RETURN TO MAIN DISPLAY, PRESS:

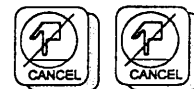

Password Level 0 Protected

Function 5: MATSAVER [View/Set Material Saver Commands]

The MATSAVER Function allows you to enter into two separate Material Saver Functions:

- 51: **MS RESET Password 1 Protected [Returns dryer to Primary Setpoint if Material Saver is active]**
- 52: **MS SETUP Password 2 Protected [Configure and Enable/Disable Material Saver Parameters]**

If the dryer is running in Material Saver Setpoint, Function 51, MS RESET, will return dryer to its primary setpoint (accessible in Function 1). Please note: If Material Saver is still enabled and the parameters you have set for Material Saver Mode (further details follow) are still valid, the dryer may immediately revert to Material Saver Mode.

Once again, you may enter MS RESET via Function 5, MATSAVER, or directly using Function 51.

To access MS RESET via Function 5:

Please refer to Section 8.8 Material Saver for complete information.

Any of these Schedule Commands may be entered into directly by keying in the appropriate Function Code as described on page 17.

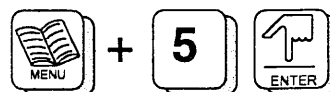
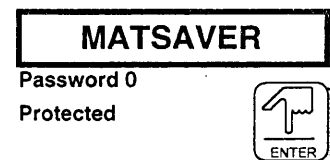
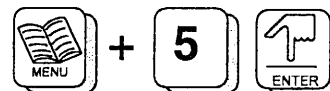

Press the Enter key again to display the first command under the MATSAVER heading. This brings us to MS RESET

Press Enter again and you will have executed a Material Saver Reset - If Material Saver is active.

To go directly to MS RESET you may enter Function 51 and press the Enter key.

Press Enter again and you will have executed a Material Saver Reset.

If you do not wish to reset Material Save Mode, press Cancel.

To setup your parameters for Material Saver you must key-in Function 52, MS SETUP.

Refer to Section 8.8 for complete information on how to enter Material Saver Commands.

Note: Every 3 minutes if Material Saver Mode is active the Message Window will display MS 1 = XXX (XXX being the current active Material Saver Setpoint), rather than T1 = XXX.

To Review — Related Function Codes at this "tree level":

- 51 [MS RESET] Material Saver Reset
- 52 [MS SETUP] Set Material Saver Parameters

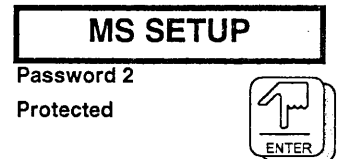
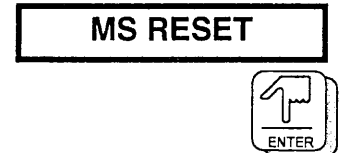
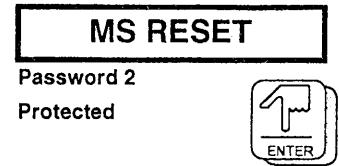

TO RETURN TO PREVIOUS "TREE" PROMPT, PRESS:



TO RETURN TO MAIN DISPLAY, PRESS:



CAUTION

DRYERS EQUIPPED WITH RETURN AIR THERMOCOUPLE AND EQUIPPED WITH RETURN AIR COOLING COIL MUST HAVE THE RETURN AIR THERMOCOUPLE MOUNTED AT EITHER COOLING UNIT INLET OR AT THE HOPPER AIR OUTLET FOR MATERIAL SAVER TO OPERATE PROPERLY.

Password Level 0 Protected

Function 6: SQC [View Statistical Quality Control Commands]

There are several bits of information which can be reviewed while in Function 6, SQC:

These functions include:

- 61: **AVG TEMP [View Average Process Air Temperature]**
- 62: **AVG DEWP [View Average Dewpoint]**
- 63: **T STD DV [View Process Air Temperature Standard Deviation]**
- 64: **DP ST DV [View Dewpoint Temperature Standard Deviation]**

You may enter via Function 6, SQC then using the Menu key to toggle down to your selection (example at right).

You may also enter directly by entering the appropriate Function Code (example at right).

To Review — Related Function Codes at this "tree level":

- 61 [AVG TEMP] View Average Process Air Temperature.
Password 0 Protected.
- 62 [AVG DEWP] View Average System Dewpoint.
Password 0 Protected.
- 63 [T STD DV] View Process Air Temperature Standard Deviation
Password 0 Protected
- 64 [DP ST DV] View Dewpoint Temperature Standard Deviation
Password 0 Protected

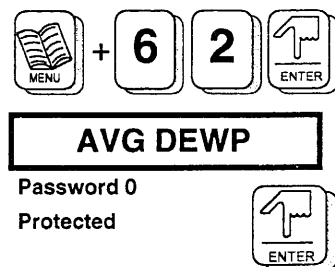
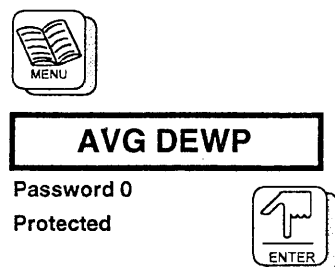
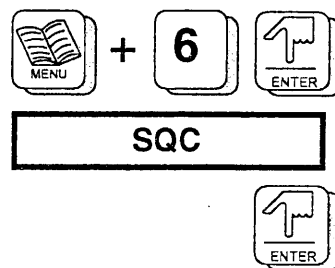
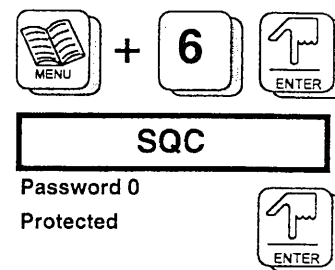

TO RETURN TO PREVIOUS "TREE" PROMPT, PRESS:



TO RETURN TO MAIN DISPLAY, PRESS:

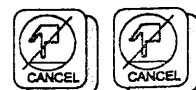

Password Level 1 Protected

Function 7: SHUT DOWN

The SHUTDOWN Function allows the unit to cease operation but power will still be supplied to the controller making it able to respond to Batch & Comm. Commands.

After pressing the Enter key the Message Window will display a confirmation prompt as illustrated at right.

If you wish to abort the shutdown, press the Cancel key or the Number 3 key which is also the NO key.

If you wish to continue with dryer shutdown, press the Enter key or the Number 1 key which is also the YES key.

The Message Window will display *WAIT* for approximately 5 seconds then read *SHUTDOWN*, again for approximately 5 seconds.

Press the Cancel key to return to the Main Display.

If you continue with Shut-Down, at this point the Message Window enters its "idle" display. This assures you that the unit is "off" via either a Batch Command, Communications Commands or through Function 7: SHUTDOWN.

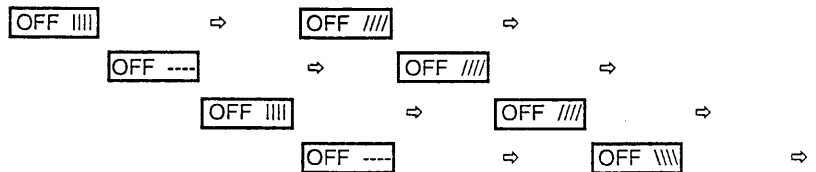

Note: if Vacuum Closed Loop (VCL) is set to load when dryer is in shutdown the display will be as illustrated at right.

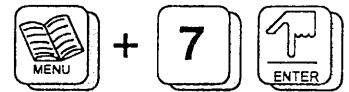
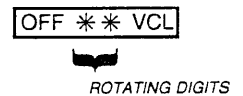

SHUTDOWN

Password 1
Protected



SURE ?



or



SURE ?



or



WAIT

SHUTDOWN

TO RETURN TO PREVIOUS "TREE" PROMPT, PRESS:



CAUTION

USING SHUTDOWN IN LIEU OF THE POWER ON/OFF SWITCH ALLOWS THE DRYER TO STILL RESPOND TO BATCH COMMANDS, COMM QUERIES AND/OR COMM COMMANDS.

*To Review — Related Function Codes at this "tree level":
NONE*

Password Level 1 Protected

Function 8: START-UP

Entering Function 8: START-UP will force the machine to reenter service (via either Quick Start ("Quiktime") or Re-Start).

A "Quiktime" delay time may be entered or you may use the factory default of 10 hours.

What is "Quiktime" versus Re-Start? "Quiktime" is machine recovery from "off" time. The unit returns to the beginning of the cam cycle* for the bed being used for regeneration. With Re-Start the unit begins operation from where shutdown occurred.

For example: with a Quiktime of 10 hours; if the unit has been "off" for less than 10 hours you will enter Re-Start — if the unit has been "off" for 10 hours or more you will enter Quick Start.

Note: Quiktime does not automatically return you to cam 00; you will return to the first cam cell on the bed which is currently being processed - either 00 OR 50.

Note: 0 = NO Quiktime Start / Allowable setting are 004 to 166 hours

To Review — Related Function Codes at this "tree level":
NONE

(See Function 112 for further information on "Quiktime")

***Cam Cells detailed on page 40**

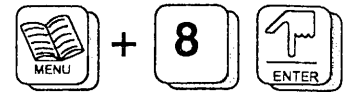

START-UP

Password 1
Protected



RESTART

QUIKSTRT

TO RETURN TO MAIN
DISPLAY, PRESS:



TO RETURN TO PREVIOUS
"TREE" PROMPT, PRESS:



Password Level 2 Protected

Function 9: ALARMS [Configure Dryer Alarm Settings]

Alarms may be configured in any combination of the following:

- Fatal or Non-Fatal [Fatal Alarms Shut the Machine Down]
- Energize the Alarm Output or Not energize the Alarm Output
- Light the Alarm LED on the dryer front panel or Not light the Alarm LED

For example; an Undertemperature Alarm could be configured to Non-Fatal, but still energize the Alarm Output AND light the Alarm LED on the dryer front panel.

Following are factory defaults for your dryer. *Notice that not all alarms are present on all dryers.*

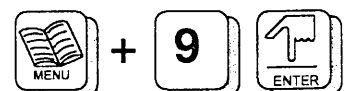

ALARMS

Password 2
Protected



ALARM LIBRARY - FACTORY INSTALLED DEFAULTS - Not All Alarms Available on UDC								
ALARM NAME	FATAL	OUTPUT ON	LED ON	OPT EQUIP REQ'D	SELF RECOVERING	SEE NOTE BELOW	UDC 1-HTR	UDC 2-HTR
OVERTMP1 Overtemperature at Process Heater 1	X ^a	✓	✓		✓		✓	✓
UNDRTMP1 Undertemperature at Process Heater 1			✓		✓	a	✓	✓
VALV ERR - not available on Model UDC Valve Proofing Error								
LBEDNOTE - not available on Model UDC Left Bed Regeneration Notice								
RBEDNOTE - not available on Model UDC Right Bed Regeneration Notice								
BED PROT - not available on Model UDC Regeneration Protective Thermostat Failure								
REGNFILT - not available on Model UDC Regeneration Filter Dirty								
PROCFILT Process Filter Dirty			✓	✓			✓	✓
HTR1PROT - not available on Model UDC Process Heater 1 Protective Thermostat Failure								
DEW ALRM Dewpoint Above Pre-Set Limit						a	✓	✓
NVR FAIL Non-Volatile Ram Chip Failure	X ^a	✓	✓			b	✓	✓
BEDSENSR - not available on Model UDC Regeneration Sensor Error								
CLOCKERR Internal Clock Chip Error			✓				✓	✓
HOP1 LOW Material Low at Hopper 1		✓	✓	✓	✓		✓	✓
OVERTMP2 Overtemperature at Process Heater 2	X ^a	✓	✓		✓			✓
UNDRTMP2 Undertemperature at Process Heater 2			✓		✓	a		✓
BED OVER - not available on Model UDC Regeneration Temperature Above Pre-Set Limit								
HTR2PROT - not available on Model UDC Process Heater 2 Protective Thermostat Failure								
BLWRFAIL Blower Failure	X ^a	✓	✓				✓	✓
SENSERR1 Sensor 1 Failure	X ^a	✓	✓				✓	✓
SENSERR2 Sensor 2 Failure	X ^a	✓	✓					✓
HOP2 LOW Material Low at Hopper 2		✓	✓	✓	✓			✓
CUSTALRM Customer Alarm	X ^a	✓	✓	✓	✓		✓	✓

a - only self-recovering when non-fatal

b - non-configurable alarm - always fatal - does not appear in Alarm Library

After entering Function 9, each time you press the Menu key another alarm in the Alarm Library will be displayed.



ALARMS

When the alarm you wish to configure is displayed press the Enter key to begin the configuration procedure.

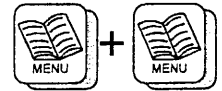

VALV ERR

In our example we will configure a Valve Proofing Error to be:

1. Fatal
2. Turn Alarm Output "ON" - Factory installed default / can be configured.
3. Turn LED on dryer front panel "ON" - Factory installed default / can be configured.



Press the Enter key to gain access.

The Message Window will display the prompt for a Fatal Alarm. You use the Menu key to toggle between:

- NO = Non-Fatal
- YES = Fatal

When you have your desired alarm condition press the Enter key.

FATL = NO



to toggle to **ON** so that the alarm is now "FATAL" @ alarm

FATL = YES



The Message Window will display the prompt for the Output to be "ON". You use the Menu key to toggle between:

- NO = Output "off" during this alarm notice
- YES = Output "on" during this alarm notice

When you have your desired alarm condition press the Enter key.

OUTP = NO



to toggle to **ON** so that the output is now "ON" @ alarm

OUTP = YES



The Message Window will display the prompt for a LED "ON" or "OFF". You use the Menu key to toggle between:

- NO = LED OFF
- YES = LED ON

When you have your desired alarm condition press the Enter key.

LED = NO



to toggle to **ON** so that the output is now "ON" @ alarm

After pressing the Enter key you will be back at the *Valve Proofing Error* prompt.

LED = YES



Press the Menu key to advance to the next alarm to be configured, for example: LBEDNOTE [Left Bed Regeneration Notice].

VALV ERR



This is the same procedure you will use throughout to configure all alarm settings.

LBEDNOTE

To Review — Related Alarm Configure Functions at this "tree level" (remember that all alarm settings are not used on all dryers):

- OVERTMP1 - Overtemperature at Process Heater 1
- UNDRTMP1 - Undertemperature at Process Heater 1
- VALV ERR - Not Available on UDC
- LBEDNOTE - Not Available on UDC
- RBEDNOTE - Not Available on UDC
- BED PROT - Not Available on UDC
- REGNFILT - Not Available on UDC
- PROCFILT - Process Filter Dirty
- HTR1PROT - Not Available on UDC
- DEW ALRM - Dewpoint Above Pre-Set Limit
- NVR FAIL - Non-Volatile Ram Chip Failure
- BEDSENSR - Not Available on UDC
- CLOCKERR - Internal Clock Chip Error
- HOP1 LOW - Material Low at Hopper 1
- OVERTMP2 - Overtemperature at Process Heater 2
- UNDRTMP2 - Undertemperature at Process Heater 2
- BED OVER - Not Available on UDC
- HTR2PROT - Not Available on UDC
- BLWRFAIL - Blower Failure
- SENSERR1 - Sensor 1 Failure
- SENSERR2 - Sensor 2 Failure
- HOP2 LOW - Material Low at Hopper 2
- CUSTALRM - Customer Alarm

TO RETURN TO PREVIOUS "TREE" PROMPT, PRESS:



TO RETURN TO MAIN DISPLAY, PRESS:

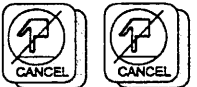

NVR FAIL - Non-Configurable / FATAL / Does not appear in Alarm Library.

Password Level 0 Protected

Function 10: PASSWORD [Enable/Disable Passwords - Configure Password Levels 1 and 2]



Allows operator/management to Enable or Disable Password Protection and/or set Password Code numbers for Levels 1 and/or 2.

PASSWORD

Password 0
Protected



PASS SET

Password 2
Protected

PASS SET is Password 2 Protected so to enter and change Protection from OFF to ON or from ON to OFF you will need to enter Password 2



Note: Factory Install Default for Level 2 = 2222
 Factory Installed Default Level 1 = 1111

As you enter the *Password Code* using the Numbered keys you will see a "star" as each digit is entered.



After successfully entering the required Password Code you will be allowed to continue.



You may toggle to the desired position using the Menu key.



As always you may access directly by entering:

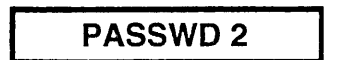
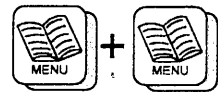

- Function 101 for PASS SET - where you may Enable/Disable Password Protection. *Password 2 Protected.*
- Function 102 for PASSWD 1 - where you set the Level 1 Password Code Number. *Password 1 Protected.*
- Function 103 for PASSWD 2 - where you set the Level 2 Password Code Number. *Password 2 Protected.*



After successfully entering Function 101 you may use the Menu key to toggle to so that you may turn Password Protection ON or OFF. After making your selection press the Enter key.

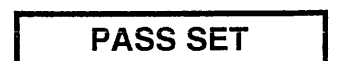

However you enter into Function 102 or 103 you will be asked if you wish to change the Level 1 Password Number Code. Enter the desired code using the Numbered keys. As you enter each number (all Password Number Codes are 4 digits) a "star" will appear on the Message Window display.

In the example at right the Level 1 Password Code number is entered as 2112.

After entering the current Password Level 1 code you may begin to make any changes.

The Message Window prompts you with: NEW 1

As each number is entered a "star" appears in the Message Window.

You will be asked to twice enter your selection for confirmation.

After successfully entering your selection for Password 1 the Message Window will return to the prompt: PASSWD 1

Press the Cancel key to revert to the prompt: PASSWORD

If the same code is not entered each time you will see *No Match* displayed in the Message Window.

In *No Match* appears you must again enter, twice, your desired Level 1 Password Code Number.

PASS = ON



to toggle to ON so that Password Protection is now OFF

PASS = OFF



PASSWD 1



NEW1



NEW1 ****

CONFIRM



PASSWD 1



PASSWORD

NO MATCH

Note: There are 4 Levels of Password Protection:

- Password Level 0 - No Password Required
- Password Level 1 - May be disabled / May be entered using a Password Level 1 or 2 code.
- Password Level 2 - May be disabled / May be entered using a Password Level 2 code only.
- Password Level 3 - MAY NOT be disabled / May be entered using a Password Level 2 code only.

TO RETURN TO PREVIOUS "TREE" PROMPT, PRESS:



To Review — Related Function Codes at this "tree level":

- 101 [PASS SET] Enable/Disable Password Protection
- 102 [PASSWD 1] Set Level 1 Password Number Code
- 103 [PASSWD 2] Set Level 2 Password Number Code

TO RETURN TO MAIN DISPLAY, PRESS:

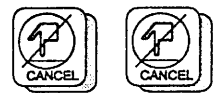

Password Level 0 Protected

Function 11: CONFIG [Configure Temperature Scale, Quick Start Time Delay and Communications Address]

The *Config Function* allows you to choose:

- Units of Measurement (Fahrenheit or Celsius/Centigrade)
- set the Delay Time for Quick Start
- Set the Communications Address

After entering Function 11 press the Enter key and you be able to change the Temperature Scale.

You may scroll to QWIKTIME or ADDRESS using the Menu key.

Or you enter directly by inputting the appropriate function code(s):

- 111 [TMPSCALE] Set Temperature Scale for Fahrenheit or Celsius/Centigrade
Password 2 Protected
- 112 [QWIKTIME] Set Quick Start Time Delay
Password 2 Protected
- 113 [ADDRESS] Set Communications Address
Password 2 Protected
- 114 [VCL A] Set Load Time and Enable/Disable VCL A Loading Package
Password 2 Protected
- 115 [VCL B] Set Load Time and Enable/Disable VCL B Loading Package
Password 2 Protected

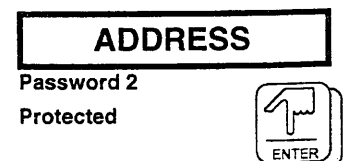
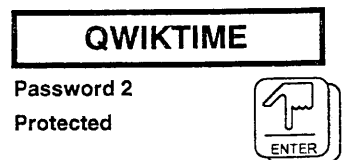
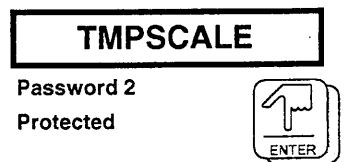
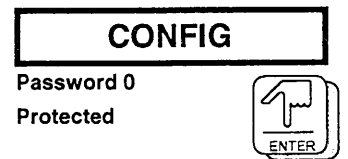

For example, after entering Function 111 you use the Function key to toggle between units in Fahrenheit or Celsius/Centigrade.

When the desired temperature scale is selected press the Enter key.

Press either the Menu key to continue to QWIKTIME, then ADDRESS or the Cancel key to go back to the CONFIG prompt.

A Quick Start delay time may be entered or you may use the factory default of 10 hours.

What is Quick Start versus Re-Start? Quick Start is machine recovery from "off" time. The unit returns to the beginning of the cam cycle* for the bed being used for regeneration. With Re-Start the unit begins operation from where shutdown occurred.

For example: with a Quick Start time of 10 hours; if the unit has been "off" for less than 10 hours you will enter Re-Start — if the unit has been "off" for 10 hours or more you will enter Quick Start.

Note: Quick Start does not automatically return you to cam 00; you will return to the first cam cell on the bed you are currently being processed - either 00 OR 50.

Note: **0 = NO Quick Start / Allowable setting are 004 to 166 hours**
***Cam Cells detailed on page 40**

Valid Addresses are,
 for SPI - Minimum=32 Maximum=254
 for Una-Dyn Network - Minimum=1 Maximum=128

Note: To disable communications at the machine: disconnect cable or set three digit code to 000.

After you have made your Communications Address selection, press the Enter key.

To Review — Related Function Codes at this "tree level":

- 111 [TMPSCALE] Select Temperature Scale
- 112 [QWIKTIME] Set Quick Start Delay Time
- 113 [ADDRESS] Set Communications Address

Note: A cable to connect the dryer to molding equipment for SPI communications is available without cost from the factory. Contact the Service Department at 703.491.2191 (703.491.6898 - fax) with cable length.

- 114 [VCL A] Set VCL A Load Time and Enable / Disable System
- 115 [VCL B] Set VCL B Load Time and Enable / Disable System

See Section 10: Vacuum Closed Loop System for complete information and key-in sequence.

FAHRENHT



to toggle between temperature scales.

CELSIUS



QWIKTIME



TIME=XXX

0 1 0

TIME=010



ADDRESS



ADDR=000

1 1 1

ADDR=111



TO RETURN TO PREVIOUS "TREE" PROMPT, PRESS:



Password Level 0 Protected

Function 12: DIAGNOSE [Initiate Dryer Service Diagnostics Program]

There are two separate Diagnostics Programs standard with the FN Controller:

1. Function 121 - RUN DIAG [Dryer Run-Time Diagnostics]

Dryer will continue to function and provide the necessary dry air to the hopper and dryer setpoint remains intact. At prompt press Enter to begin.

After entering Function 121 use the Menu key to scroll through tests, or enter the desired Function Code directly. Password 0 Protected.

Related Functions at this tree level include:

- Function 901 - Lamp Test - check operation of all LED's and Message Window digits. Password 0 Protected.

When the prompt is displayed, press the Enter key once to begin test. All LED's "on" and the Message window digits will begin to scroll. Press the Enter key a second time and LED's and Message Window digits begin to "flash." Press the Cancel key to leave Lamp Test.

When the Lamp Test prompt returns press the Menu key to continue

- Function 902 - Keypad Test - check operation of all push-buttons on keypad

When the prompt is displayed, press the Enter key to begin test. Message Window will prompt you with "PUSH KEY"; each time you press a key its name is displayed in the Message Window. To exit the test, press the Cancel key followed by the Enter key. Password 0 Protected.

When the Keypad Test prompt returns press the Menu key to continue

- Function 903 - AC Inputs - view AC Inputs

When the prompt is displayed, press the Enter key to begin test. Message Window will show current status of AC Inputs - a number 1 indicates the Input is active - a number 0 indicates the Input is not activated. Password 0 Protected.

Digit 1 (left-most) = Blower Pressure Switch [should display 1 when blower is "ON"]

Digit 2 = Spare [available for optional equipment]

Digit 3 = Vacuum Closed Loop Chamber "B" level switch [would display 1 if input is calling for material / will display 0 when VCL B is satisfied]

Digit 4 = Vacuum Closed Loop Chamber "A" level switch [would display 1 if input is calling for material / will display 0 when VCL A is satisfied]

Digit 5 = Process Air Filter Dirty Option [would display 1 if filter clogged input is active]

Digit 6 = Hopper 1 Material Low Option [requires material level switch at hopper; will display 1 if material 1 low input is active]

Digit 7 = Hopper 2 Material Low Option [requires second material hopper with level switch at hopper; will display 1 if material 2 low input is active]

Digit 8 (right most) = Customer Alarm [will display 1 if external shutdown input is active]

When the AC Input prompt returns press the Menu key to continue

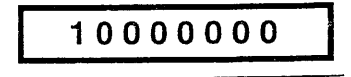
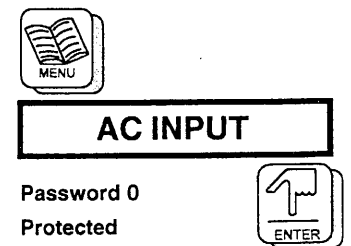
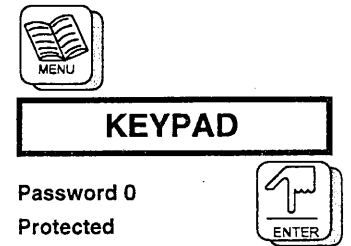
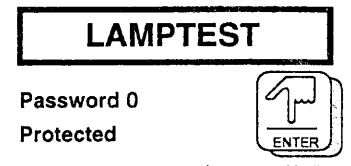
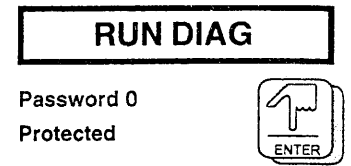

•Function 904 - Dipswitch - view position of dipswitch settings

When the prompt is displayed, press the Enter key to begin test. Message Window will show current status/position of dipswitches - a number 1 indicates the Input is active - a number 0 indicates the Input is not activated. **On current software no dipswitches are used; therefore all digits should read 0.**

When the Dipswitch prompt returns press the Menu key to continue

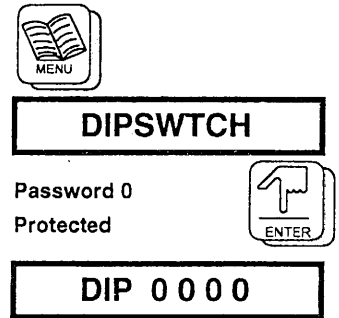

•Function 905 - Process 1 Temperature - view Process 1 Temperature in millivolts

When the prompt is displayed, press the Enter key to begin test. Message Window will show current Process 1 temperature in temperature scale selected and in millivolts for diagnostics purposes. The example at right indicates a Process Temperature at 225° and a millivolt reading of 1004.

Note: Process 1 is read by Thermocouple Number 1

When the Process 1 prompt returns press the Menu key to continue

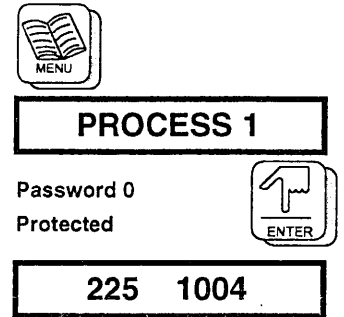

•Function 906 - Return 1 Temperature - view Return 1 Temperature in millivolts

When the prompt is displayed, press the Enter key to begin test. Message Window will show current Return 1 temperature in temperature scale selected and in millivolts for diagnostics purposes. The example at right indicates at Return air Temperature at 109° and a millivolt reading of 1012.

Note: Return 1 is read by Thermocouple Number 2

When the Return 1 prompt returns press the Menu key to continue

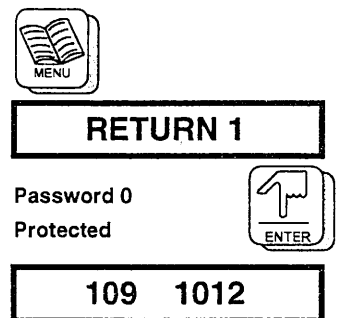

•Function 907 - Spare 1 Temperature - view Spare 1 Temperature in millivolts [Process 2 on Dual Process Heater Units]

When the prompt is displayed, press the Enter key to begin test. Message Window will show current Spare 1 temperature in temperature scale selected and in millivolts for diagnostics purposes. The example at right indicates a Spare 1 Temperature at 109° and a millivolt reading of 1012.

Note: Spare 1 is read by Thermocouple Number 3

When the Spare 1 prompt returns press the Menu key to continue

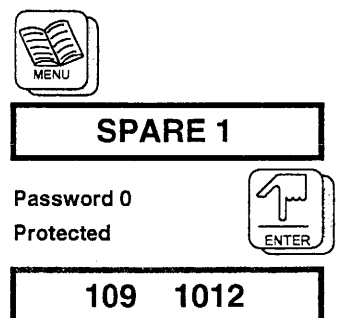

•Function 908 - Spare 2 Temperature - view Spare 2 Temperature in millivolts [Return 2 on Dual Process Heater Units]

When the prompt is displayed, press the Enter key to begin test. Message Window will show current Spare 2 temperature in temperature scale selected and in millivolts for diagnostics purposes. The example at right indicates a Spare 2 Temperature at 106° and a millivolt reading of 1010.

Note: Spare 2 is read by Thermocouple Number 4

When the Spare 2 prompt returns press the Menu key to continue

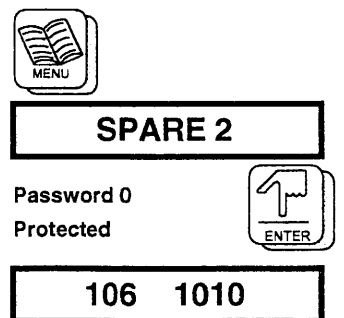

- Function 909 - Spare 3 Temperature - view Spare 3 Temperature in millivolts (For Dual Hopper Units - View Spare 1 Process Temperature in millivolts [909-SPARE 1].)

When the prompt is displayed, press the Enter key to begin test. Message Window will show current Spare 3 temperature in temperature scale selected and in millivolts for diagnostics purposes. The example at right indicates a Spare 3 Temperature at 225° and a millivolt reading of 1312.

When the Spare 3 prompt returns press the Menu key to continue

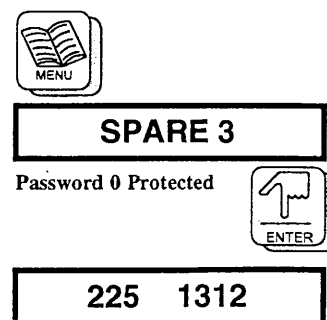

- Function 910 - Spare 4 Temperature - view Spare 4 Temperature in millivolts (For Dual Hopper Units - View Spare 2 Air Temperature in millivolts [909-SPARE 2].)

When the prompt is displayed, press the Enter key to begin test. Message Window will show current Spare 4 temperature in temperature scale selected and in millivolts for diagnostics purposes. The example at right indicates a Spare 4 Temperature at 185° and a millivolt reading of 1002.

When the Spare 4 prompt returns press the Menu key to continue

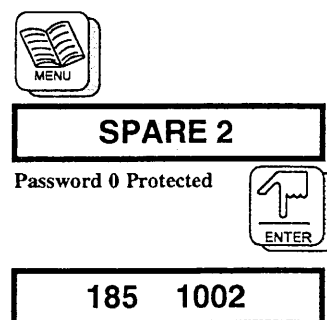

- Function 911 - Dew Diag Temperature - view Dewpoint in millivolts

When the prompt is displayed, press the Enter key to begin test. Message Window will show current Dewpoint Diagnostics temperature in temperature scale selected and in millivolts for diagnostics purposes. The example at right indicates a Dewpoint Diagnostics Temperature at -44° and a millivolt reading of 980.

When the Dew Diag prompt returns press the Menu key to continue

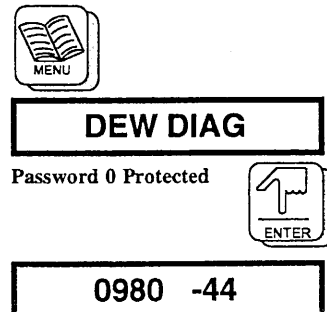

- Function 912 - Unit ID - view dryer identification information

When the prompt is displayed, press the Enter key to begin test. Message Window will scroll the:

1. *software version* of the dryer
2. *number of process heaters/hoppers* able to be served with this software (for example: 1HTR indicates one process heater may be controlled - 2HTR indicates two process heaters may be controlled) and the *Communication Protocol available*
3. *options installed* then the Message Window will revert back to the "UNIT ID" prompt.

The example at right shows a dryer with Software Version U1.00, one process heater/hopper control with SPI communications protocol and the ability to accept a Shaw Dewpoint Instrument.

When the UNIT ID prompt returns press the Menu key to continue.

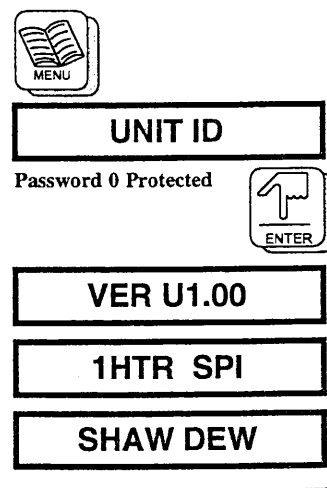

•Function 913 - Advance Cam - enables the operator to advance through Cam Table. **Password Level 3 Protection - Password 2 ALWAYS required.**

Press the Enter key to begin advancing cams will cause the controller to prompt you with: "SURE?" Press the Enter key or the Number 1 key - which also the YES key to continue.

The example at right shows the controller beginning to advance at Cam Cell 10.

Each time you press the Menu key you will advance through a portion of the cam cell.

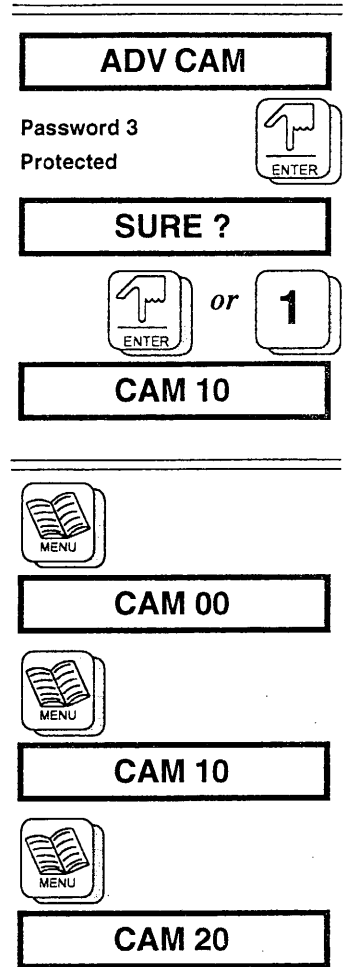

DANGER

THIS OPERATION MAY MOVE THE DRYER TO A PORTION OF THE CAM CYCLE WHERE ADEQUATE COOLING HAS NOT TAKEN PLACE. PROTECT EQUIPMENT AND MATERIAL FROM EXCESSIVE HEAT DURING THIS OPERATION.

Cam Cell Number	TIME IN CAM	BLOWER ON	LEFT BED REGEN HEAT	RIGHT BED REGEN HEAT	LEFT BED COOLDOWN	RIGHT BED COOLDOWN	PROCESS HEAT AVAILABLE	VALVE POSITION
Cam Cell 00: Changeover	10 sec	✓						2/1
Cam Cell 05**	0 to 10 min	✓					✓	1
Cam Cell 10+	10 to 12.5 min	✓	✓				✓	1
Cam Cell 20	10 min	✓			✓		✓	1
Cam Cell 50: Changeover	10 sec	✓						1/2
Cam Cell 55**	0 to 10 min	✓					✓	2
Cam Cell 60+	10 to 12.5 min	✓		✓			✓	2
Cam Cell 70	10 min	✓				✓	✓	2
Cam Cell: Return to 00	00 sec							

****Cam Cells 5 & 55: Dewpoint Extend - Controller modifies cam time from minimum of 0 seconds to a maximum of 10 minutes. Default setting is 3 minutes. See Section 8.10 for further information. Regeneration Heat Cycle: Controller artificial intelligence modifies the heater "on" time to reduce changeover heat bump while at the same time maintaining acceptable Dewpoint level. Default is 10 minutes**

2. Function 122 - SHUTDIAG [Dryer Shut-Down Diagnostics]
 Dryer will cease normal operation during "SHUTDIAG." At prompt press Enter to begin. **Password 2 Protection.** After entering Function 122 use the Menu key to scroll through tests; when the desired test is displayed press the Enter key.

- OUTPUTS** - test dryer outputs. Example at right.
 - **PROC BLWR-Process Blower Pressure Switch Test:** will display **TESTING**, then **PROOF OK**. Will test switch in ON and OFF position. If **BLWRFAIL** displayed, see Section 9.17 for information on setting Blower Pressure Switch.
 - **LBEDHT-Left Bed Heater Test:** will display **TESTING** during test. Blower ON during test to prevent heater damage.
 - **RBEDHT-Right Bed Heater Test:** will display **TESTING** during test. Blower ON during test to prevent heater damage.
 - **VALVE 1-Valve Position 1 Travel:** will display **TESTING**, then **PROOF OK** then **LEAKAGE?** [Check for excessive leakage of air from the Right Regen Port (as viewed from the rear of the dryer)].
 - **VALVE 2-Valve Position 2 Travel:** will display **TESTING**, then **PROOF OK** then **LEAKAGE?** [Check for excessive leakage of air from the Left Regen Port (as viewed from the rear of the dryer)].
 - **PROC HTR-Process Heater 1:** will display **TESTING** during test. Blower ON during test to prevent heater damage.
 - **VCL OUT- Vacuum Closed Loop Material Level Capacitance Switch (PROC HTR2 on dual process heater units):** will display **TESTING** during test.
 - **ALARM OUT-Alarm Output Test:** will display **TESTING** during test.

When the Output prompt returns press the Menu key to continue.

- CALIBRAT** - view Printed Circuit Board Calibration Diagnostics.
Requires Test Fixture - For In-House Service Department only.
- COMMDIAG** - view Communications Diagnostics.
Requires Test Fixture - For In-House Service Department only.
- RE-INIT** - Re-Initialize Dryer to Factory Defaults

This will return dryer to factory defaults. The controller will prompt you with: SURE? Press the Enter key or the Number 1 key - which also the YES key to continue.

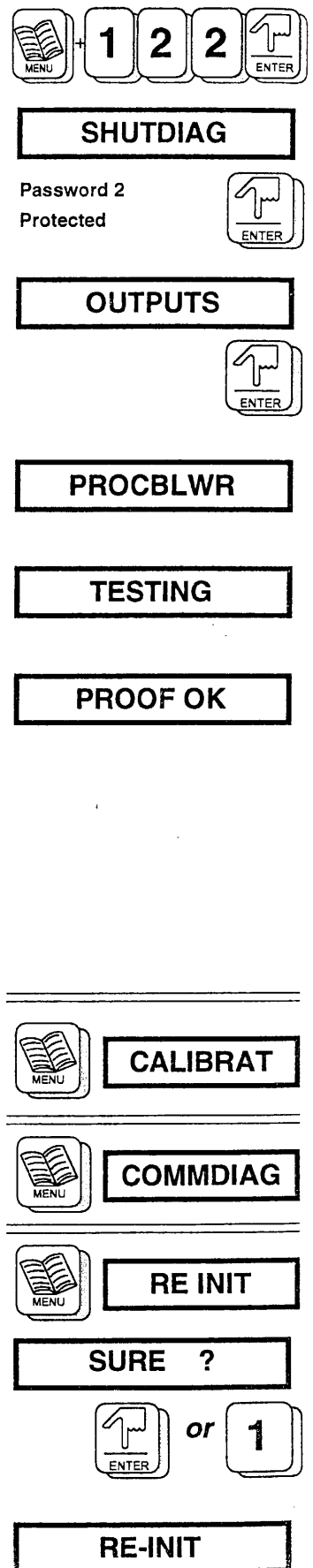

To Review — Related Function Codes at this "tree level":

- 121 [RUN DIAG] - Dryer Run-Time Diagnostics
 - 901 [LAMPTEST] - Perform Lamp Test
 - 902 [KEYPAD] - Perform Keypad Test
 - 903 [AC INPUT] - View AC Inputs
 - 904 [DIPSWTCH] - View Dipswitch Settings
 - 905 [PROCESS1] - View Process 1 Temperature
 - 906 [RETURN 1] - View Return 1 Temperature
 - 907 [SPARE 1] - View Spare 1 Temperature
 - 908 [RETURN 2] - View Return 2 Temperature
 - 909 [SPARE 3] - View Spare 3 Temperature
 - 910 [SPARE 4] - View Spare 4 Temperature
 - 911 [DEW DIAG] - View Dewpoint Diagnostics Temperature
 - 912 [UNIT ID] - View Unit ID
 - 913 [ADV CAM] - Advance Cam Cell(s)
- 122 [SHUTDIAG]
 - [OUTPUTS] - View operation of Dryer Outputs
 - [CALIBRAT] - Perform PCB Calibration Diagnostics**
 - [COMMDIAG] - Perform Communications Diagnostics**
 - [RE-INIT] - Re-Initialize Dryer to Factory Defaults

**Requires Test Fixture - For In-House Service Department only.

TO RETURN TO PREVIOUS "TREE" PROMPT



TO RETURN TO MAIN FUNCTION PROMPT



TO RETURN TO MAIN DISPLAY



8.3 View Alarm Button:

Pressing the View Alarm key and then *scrolling* with the Menu key will cause the dryer to display several bits of information in the Message Window:

—If it is a FATAL Alarm:

- A "snap shot" of conditions at the dryer before a *Fatal Alarm* occurred (very useful in troubleshooting the unit -- you instantly know which bed was in process, the dryer actual temperature at time of alarm, whether or not a regen heater was "on", etc.)
- Current Cam Cell and time remaining in the Cam Cell
- Alarm Code Name(s) if any
- End of Alarm

—If it is a NONFATAL Alarm:

- Current Cam Cell and time remaining in the Cam Cell
- Alarm Code Name(s) if any
- End of Alarm

You are only "viewing alarms" at this point so that you may gather information which may help avert further problems.

Note: If you have elected to use the *Alarm Output* for a Bell or Light; pressing the View Alarm key while the output is "ON" will turn the output "OFF" for 3 minutes. This "*Alarm Silence*" feature allows you to work on the dryer in relative peace. If you do not clear the alarm within 3 minutes the alarm output will again come "ON".



CAM CELL & TIME



FRONT PANEL DISPLAYS "SNAP SHOT" OF CONDITIONS BEFORE FATAL ALARM(S)



CAM CELL & TIME



ALARM NAME



END ALARM



8.4 Clear Alarm Button:



Pressing the Clear Alarm key will cause any alarm(s) which may have been present to immediately clear from memory.

Note: IT IS ALWAYS A GOOD IDEA TO VIEW ALARMS BEFORE CLEARING.

8.5 Cancel Button:

Pressing the Cancel key will enable you to leave any function or command. It also "unwinds" you through one tree level at a time.

The example at right shows you leaving from Function 31, DEW TRIG back to the Main Display (system Process Air Temperature and Dewpoint).

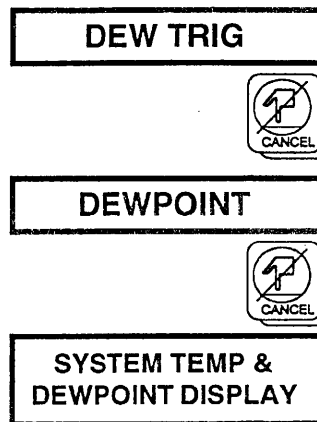

8.6 Setting the Real-Time Clock:

Function 45, SET CLOCK is under the SCHEDULE (Function 4) tree. After the prompt is displayed, press the Enter key to begin.

You use the Number keys to enter the correct time for the Real-Time Clock.

The first data to be entered is the "day."

Note:

Everyday =	0**	Sunday =	1	Monday =	2
Tuesday =	3	Wednesday =	4	Thursday =	5
Friday =	6	Saturday =	7		

**used in setting Batch Commands - presented here for reference.

Second is the "hour."

Note:

00 = 12 a.m.	01 = 1 a.m.	02 = 2 a.m.	03 = 3 a.m.
04 = 4 a.m.	05 = 5 a.m.	06 = 6 a.m.	07 = 7 a.m.
08 = 8 a.m.	09 = 9 a.m.	10 = 10 a.m.	11 = 11 a.m.
12 = 12 noon	13 = 1 p.m.	14 = 2 p.m.	15 = 3 p.m.
16 = 4 p.m.	17 = 5 p.m.	18 = 6 p.m.	19 = 7 p.m.
20 = 8 p.m.	21 = 9 p.m.	22 = 10 p.m.	23 = 11 p.m.

Third is the "minute."

00 - 59

To confirm your setting you may wish to use Function 41, View Clock

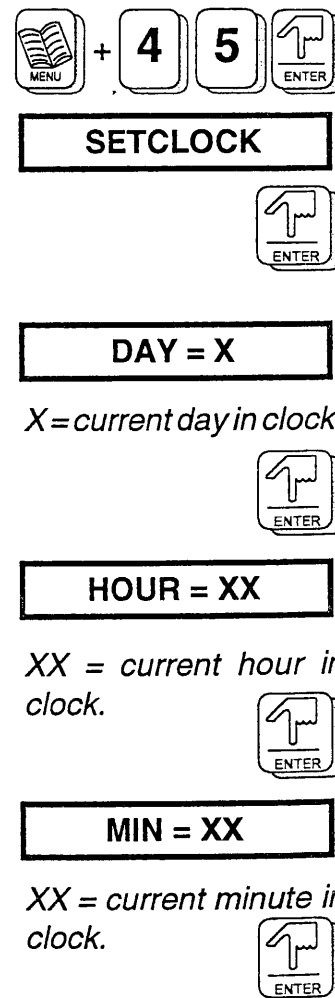

8.7 Batch Commands:

There are **two types** of Batch Commands:

- Permanent** which remain in memory until deleted by the operator

Note: A Permanent Batch Command with DAY = 0 displayed will be executed regardless of the day of the week.

- Temporary** which is deleted from memory after it is completed.

Note: A Temporary Batch Command with DAY = 0 displayed will be executed regardless of the day of the week and then deleted from memory.

SETBATCH is under the SCHEDULE tree section of the controller. You may enter via Function 4, Schedule, then using the Menu key to toggle down to SETBATCH. At this prompt press the Enter key to begin.

You may also enter directly using Function 43.

At the SETBATCH prompt, press the Enter key to begin.

You will be able to enter a Batch Command for:

- SHUTDOWN
- STARTUP
- SET TEMP

Note: Up to 10 events may be entered into the Batch Command memory.

The display will ask for the first commands in the Setbatch Table, SHUTDOWN - this is the time at which you would like a Dryer Shutdown to occur.

If no Shutdown is required, press the Menu key to go to the next command.

If this is the operation you wish begin with press the Enter key.

In our example we will program in a:

Temporary Batch Command for SHUTDOWN on Friday at 4:30 p.m.

Permanent Batch Command for STARTUP on Monday's at 7:00 a.m.

Temporary Batch Command for a Setpoint Temperature Change on Monday at 7:00 a.m. from 32° F. to 195° F.

At the SHUTDOWN prompt, press Enter, you will be asked the DAY of the week you wish the Shutdown to occur.

*Note: 0 indicates **Everyday** - we will program the Shutdown for Friday, day 6.*

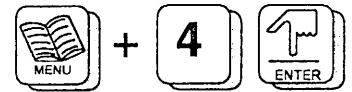

SCHEDULE

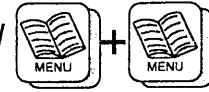

SETBATCH



SETBATCH



SHUTDOWN



DAY = X



DAY = 6

You will then be asked what hour.

HOUR = XX

1 + 6 

HOUR = 16

Then what minute.

MIN = XX

3 + 0 

MIN = 30

The controller will then prompt you with a request for TEMPRARY (Temporary) or PERMNET (Permanent):

TEMPRARY

Use the Menu key to toggle between them. In our example this is to be a Temporary Batch Command; therefore when TEMPRARY is displayed press the Enter key.

TEMPRARY



The controller will again prompt you with: SETBATCH. Press the Enter key to continue.

SHUTDOWN



Press the Menu key to toggle to the next command, STARTUP.

STARTUP



In our example, the next step is to set a Permanent Batch Command which will have the unit Startup every Monday at 7:00 a.m.

DAY = X

2 

At the STARTUP prompt, press Enter, you will then be asked the DAY of the week you wish the Startup.

DAY = 2

You will then be asked what hour.

HOUR = XX



HOUR = 7

Then what minute.

MIN = XX



+



MIN = 00

The controller will then prompt you with a request for TEMPRARY or PERMNET.

Use the Menu key to toggle between. In our example this is a Permanent Batch Command; therefore when PERMNET is displayed press the Enter key.

TEMPRARY



PERMNET



The controller will again prompt you with: SETBATCH. Press the Enter key to continue.

STARTUP

Press the Menu key to scroll to the next command, SET TEMP 1.



SET TMP 1

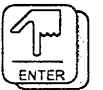

In our example, the next step is to set a Temporary Batch Command which will have the unit change the Setpoint from 32°F. to 195°F. on Monday at 7:00 a.m.

Note: Dual Hopper Units = Batch Prompt for setting temperature for Hopper Number 2 : **SET TMP 2**

See Section 8.9 for Information on Dual Hopper units.

At the SET TEMP prompt, press Enter, you will then be asked the TEMPERATURE you wish.

T1 = XXX

1 9 5

T 1 = 195



You will be asked the day of the week you wish to change the Temperature.

DAY = X

2

DAY = 2

You will then be asked what hour.

HOUR = XX

7

HOUR = 7

Then what minute.

MIN = XX

0 + 0

MIN = 00

The controller will then prompt you with a request for TEMPRARY or PERMMENT.

TEMPRARY



Use the Menu key to toggle between. In our example this is a Temporary Batch Command; therefore when TEMPRARY is displayed press the Enter key.

TEMPRARY



The controller will again prompt you with SETBATCH.

SETBATCH

Press the Cancel key once to return to the prompt, SCHEDULE.

Press the Cancel key twice to return to the main prompt.

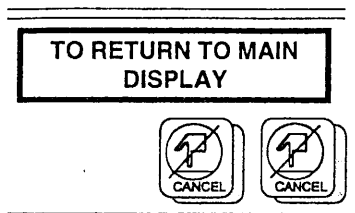

To review your selections:

VW BATCH is under the SCHEDULE tree section of the controller. You may enter via Function 4, Schedule, then using the Menu key to scroll down to VW BATCH.



You may also enter directly using Function 42.

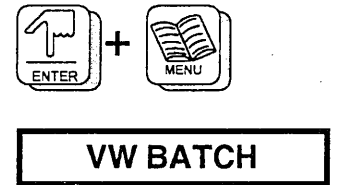

At the VW BATCH prompt, press the Enter key to begin.



At each press of the Menu key another Batch Command Time will be displayed. If you wish to view the Command Type associated with a particular time press the Enter key.

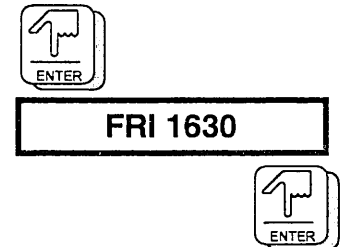

From the previous example you would see:

First the *Time* is displayed, press the Enter key and the *Command* to take place is displayed. This indicates a Temporary Batch Command for SHUTDOWN on Friday at 4:30 p.m.



This indicates a Permanent Batch Command for STARTUP on Monday at 7:00 a.m.



*Note: The symbol * you see between the day and the time indicates that this is a Permanent Batch Command, and as such will repeat until deleted from memory.*



During the time the unit is "off" from a Batch Command (or for any Shutdown) the Message Window will show the "idle" display.



This indicates a Temporary Batch Command for SETTEMP change of 195 degrees F. on Monday at 7:00 a.m.

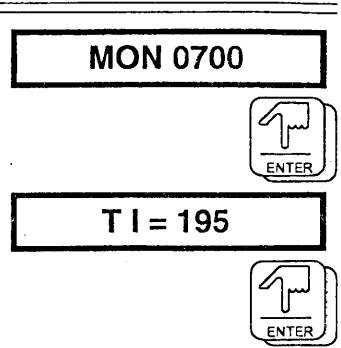

When you have finished viewing all Batch Commands entered into memory the display will show: ENDBATCH

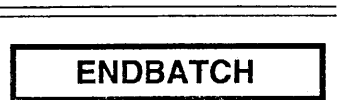

To Delete Batch Commands:

DELBATCh is under the SCHEDULE tree section of the controller. You may enter via Function 4 - Schedule, then using the Menu key to toggle down to DELBATCh.

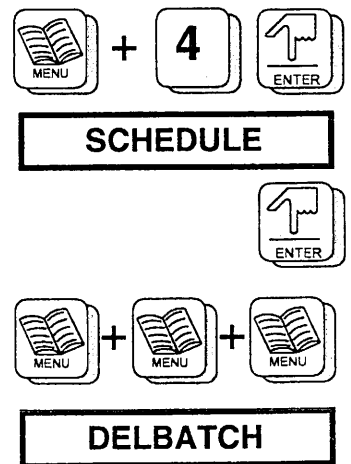

You may also enter directly using Function 44.

At the DELBATCh prompt, press the Enter key.

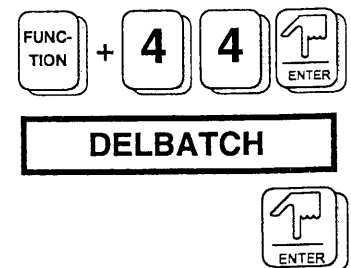

At each press of the Menu key another Batch Command will be displayed.

When the appropriate *Batch Time and Command* is displayed press the Enter key to delete.

The controller will prompt you with: DELETE ?

Press the Enter key or the Number 1 key which is also the YES key to delete that Batch Command from memory. Pressing Cancel key or the Number 3 key which is also the NO key to cancel the operation.

Using the Menu key you may toggle down and delete any or all of the entire Batch Command library.

When all Batch Commands are removed, *or if none were in memory*, the controller will prompt you with: ENDBATCH. This indicates that the memory is completely clear.

Related Function Codes at Batch Command "tree level":

- 43 [SETBATCH] Set Batch Commands
- 44 [DELBATC] Delete Batch Commands

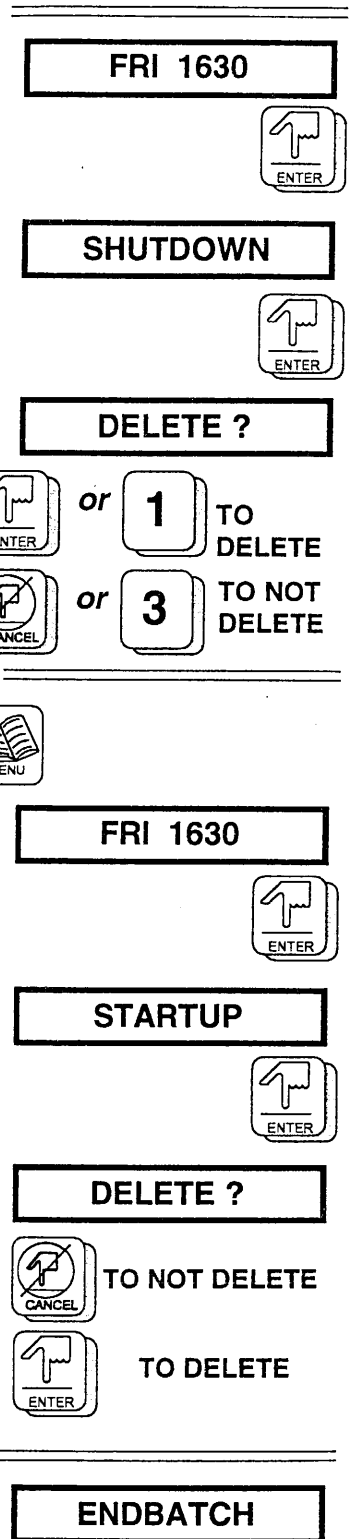

8.8 Material Saver Mode:

In MATERIAL SAVER MODE the **temperature of the air returning from the material hopper is monitored** in order to tell when a reduction in material usage occurs, indicated by the return air approaching setpoint.

When the *return air temperature equals the setpoint minus DELTA T 1* (Delta T 1 is set by the user) you know that all of the material in the material hopper is approaching temperature; therefore material usage has either stopped (i.e. a mold change) or slowed drastically.

Rather than continue to expose already dry material to setpoint temperatures the dryer will temporarily change the setpoint to the Material Saver Setpoint (set by the user).

When material usage resumes, this will be detected by a drop in the return air temperature caused by fresh cool material loaded into the hopper.

When the *return air temperature from the hopper drops to Material Saver Setpoint minus Delta T2* (Delta T 2 is set by the user), then the original drying temperature is reinstated and normal operation is resumed.

Additionally, Material Saver Mode will be cancelled when you: a) Turn the Power ON/OFF switch to OFF -or- b) Change the primary Setpoint.

For example:

- SETPOINT TEMPERATURE = 300° F.
- MATERIAL SAVER PROCESS TEMP = 200° F.
- DELTA T 1 = 25° F.
- DELTA T 2 = 25° F.

When the *return air reaches 275° F.* (Setpoint minus delta T 1) then the dryer will go into Material Saver Mode (**when in Material Saver Mode an "M" will be displayed in the Message Window**) and the process temperature will be set to 200° F.

This condition will remain until fresh material is introduced into the hopper and the return air temperature falls to 175° F. (Material Saver Process Temperature minus delta T 2) at which time the setpoint will go back to 300° F.

The following pictorial representation may offer some further insight as you follow the Return Air Temperature curve.

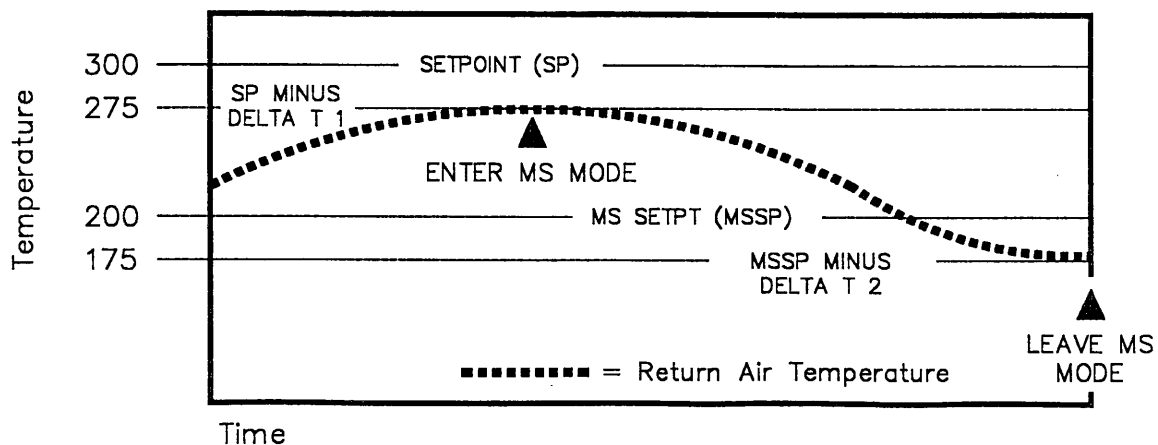

To enter Material Saver Mode key-in Function 5, MATSAVER then toggle to MS SETUP using the Menu key.



You may also enter MS SETUP directly using Function 52.



At the prompt, press the Enter key to begin.



The display shows the current "Material Saver Setpoint" MSP 1. In the example at right *XXX is the current MSP 1 temperature.*

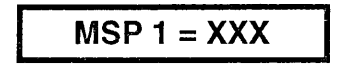

Enter in the desired temperature using the Numbered keys; in our example we will use 200° F.



Note that the Message Window reflects the changes as they are entered.

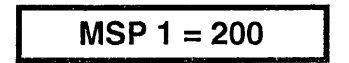

After keying in the selection, press the Enter key to continue to the next step.



The controller will prompt you for the Delta T 1 Temperature: In our example *we used a Delta T1 of 25° F.*

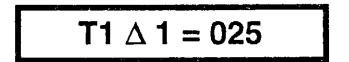
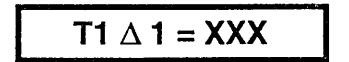

The controller will then prompt you for the Delta T 2 Temperature: In our example *we used a Delta T 2 of 25° F.*

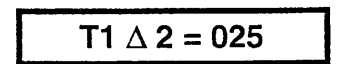
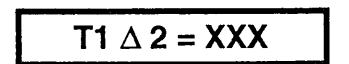

What this means to us is that when the controller sees a return air temperature of 275° F. (Setpoint of 300° F. -minus- Delta T 1 of 25° F.) the unit will automatically entering to Material Saver Mode.

When the controller sees a return air temperature of 175° F. (Material Saver Setpoint -minus- Delta T 2 of 25° F.) the unit will automatically drop out of Material Saver Mode and return to the original Setpoint Temperature of 300° F.

When all information has been entered the Message Window will display: MS 1 OFF.

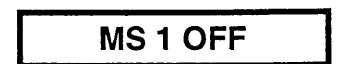

Press the Menu key to the MS1 SET display and press the Enter key. At this point the entries are locked into memory and the operation is complete.



MS1 SET



If you have entered "bad" numbers (outside of the allowed parameters) the display will read: PARM ERR

PARM ERR

To review the example from the previous page.

Material Saver Setpoint (**MSP 1 = 200° F.**) must be less than the Primary Setpoint (**PSP = 300° F.**), AND the Primary Setpoint *minus* Delta T 1 (**T1 D 1 = 25° F.**) must be greater than MSP1 *minus* Delta T 2 (**T1 D 2 = 25° F.**)

$$\begin{aligned} \text{MSP 1} &< \text{PSP} \\ \text{PSP} - \text{T1 D 1} &> \text{MSP 1} - \text{T1 D 2} \end{aligned}$$

Function 51, MS RESET, will temporarily return the dryer to its Primary Setpoint and prompt you with **MS CLEAR**. **If the dryer was in Material Saver Mode. If not the Message Window display will not change.**



MS RESET

Note: If the parameters you have entered for Material Saver Mode are still valid (your Return Air Temperature has reached Delta T 1 for example), the controller may immediately return to running its Material Saver Setpoint.

Material Saver Mode will also be disabled (you revert to Primary Setpoint) when you: a) Change the Primary Setpoint (Material Saver can only react to one Primary Setpoint) or b) Disable manually using Function 52.



MS CLEAR

Note: If you are in the Material Saver Mode at "Power OFF" when power is returned and the dryer resumes operation it will "power ON" at the Primary Setpoint - then, if the Material Saver Parameters are still valid the machine will go into the Material Saver Mode.

Related Function Codes at Material Saver "tree level":

- 51 [MS RESET] Material Saver Reset
- 52 [MS SETUP] Set Material Saver Parameters

CAUTION

WHEN USING MATERIAL SAVER IN CONJUNCTION WITH A RETURN AIR COOLING COIL THE THERMOCOUPLE MUST BE PLACED AT THE HOPPER AIR OUTLET PRIOR TO AIR ENTERING THE COOLING COIL FOR CORRECT OPERATION.

8.9 Dual Process Heater Units:

Dual Process Heater units will always offer two prompts for information display and/or programming requests.

For example:

Function 1: Set Temp [Set Process Temperature]

After keying in Function 1, the display will prompt you with: SET TEMP.

Press the Enter key and the display will prompt: T1 = XXX
XXX is the current Setpoint temperature

After keying in the selection, press the Enter key and the display will prompt you for the second Setpoint entry: T2 = XXX
XXX is the current Setpoint temperature

Enter the desired Setpoint for Process Heater Number 2, press the Enter key and the unit reverts back to the SET TEMP prompt.

Several operations will require inputting data for dual process heaters.

- Function 1 - SET (PROCESS) TEMPERATURE
- Function 2 - SET DELTA OVER-TEMPERATURE
- Function 5 - MATSAVER (SET MATERIAL SAVER PARAMETERS)
- Function 43 - SET BATCH COMMANDS
- Function 113 - SET COMMUNICATIONS ADDRESS (SPI Protocol)

When in Dryer Run-Time Diagnostics Mode several new options are available when using dual process heaters.

- Function 907- VIEW PROCESS 2 TEMPERATURE IN MILLIVOLTS
- Function 908 - VIEW RETURN 2 TEMPERATURE IN MILLIVOLTS

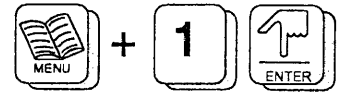

SET TEMP



T 1 = XXX



T 2 = XXX



SET TEMP

CAUTION

WHENEVER TWO PROMPTS OR DISPLAYS ARE REQUIRED THE FIRST DISPLAY OR PROMPT WILL BE FOR PROCESS HEATER NUMBER 1 AND THE SECOND DISPLAY OR PROMPT WILL BE FOR PROCESS HEATER 2.

During normal operation both Process Air temperatures will be displayed.

The "flashing" **H** is displayed whenever process heater number 2 is "ON"; the Process Heater LED on the display panel blinks for process heater number 1.

Note: Every 30 seconds, the currently detected system Dewpoint is displayed.

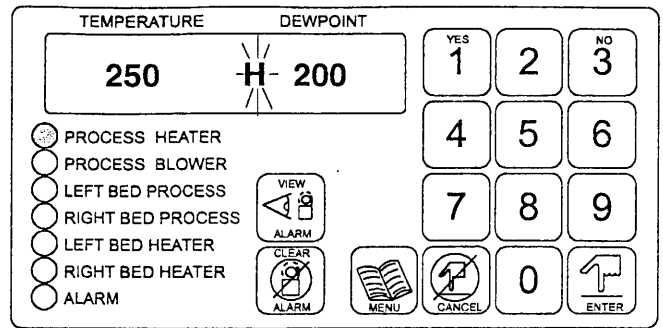

Note: Every 60 seconds the Message Window display changes to:

- a) show Setpoint for Process Heater Number 1
- b) show Setpoint for Process Heater Number 2

In the event that Material Saver is enabled and active the Message Window will give you the Material Saver Setpoint for the appropriate hopper.

It is possible to alternate between Primary Setpoint and Material Saver Setpoints; the example at right shows a Primary Setpoint for Process Heater Number 1 at 250° Fahrenheit and a Material Saver Number 2 Setpoint of 160° Fahrenheit.

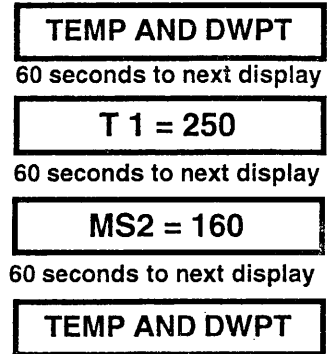

8.10 Dewpoint Extend:

Dewpoint Extend extends the normal Cam Cell or Cycle and allows the dryer to remain on a viable tower until that bed reaches a point of moisture saturation that produces a dewpoint *greater* than the Dewpoint Trigger Value you have programmed in using Function 31. The controller "samples" the dewpoint and increases or decreases Cam Cells 5 and 55 by 15 second increments. The minimum amount of time allowable in Cam Cells 5 and 55 is zero seconds while the maximum allowable time is 10 minutes.

•32: DP EXTND has two settings.

DPEXT ON - Dewpoint Extend Enabled. The dryer will incorporate the Dewpoint Extend Cam Cells* into the timing cycle.

DPEXT OFF - Dewpoint Extend Disabled. The dryer will follow the normal timing cycle as shown in the Cam Cell Table.

After entering Function 32, the Message Window will display **DP EXTND**. To enter into this section of the Function Code "tree" press the Enter key.

The first prompt displayed is **DPEXT OFF**. You may use the Menu key to scroll through your selections.

When the desired Dewpoint Extend function is displayed press the Enter key.

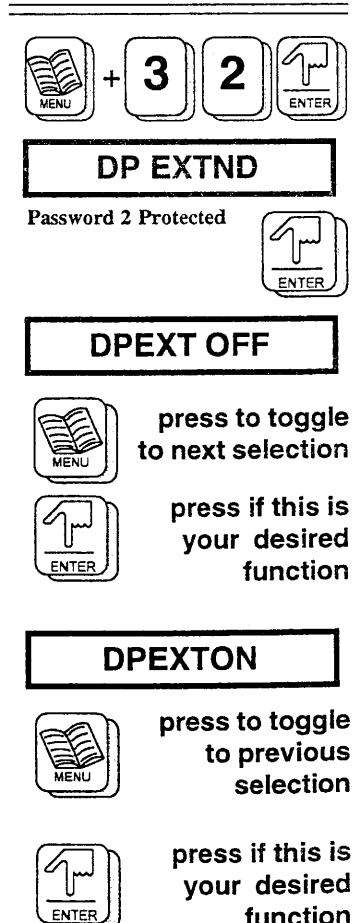

9. MAINTENANCE

9.1 Filters:

Inspect all filters regularly, cleaning on a regular maintenance schedule or when visibly dirty. Replace if necessary. A dirty filter restricts airflow and will impair dryer performance.

Frequency of filter change can only be determined by operating experience. It will depend upon the air quality in the shop and the characteristics of the plastics.

CAUTION

FILTERS SHOULD BE CHECKED ONCE A SHIFT.

Blower Filter

Processed (dry) hot air is continuously blown into the hopper, through the spreader cone and up through the plastic material. The dry air draws moisture from the plastic, exits the hopper, passes through the filter and enters the blower inlet. To change or clean the filter cartridges, remove the lid and pull out the element. You may use compressed air to blow dust and fines out of filter elements blowing **from the inside - out**.

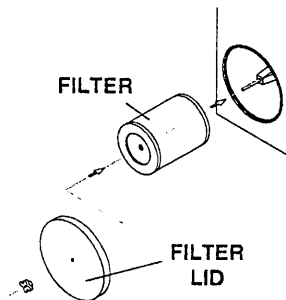

Plasticizer Filter

Airborne vapor given off by some resins can substantially degrade the performance of desiccant and **must be removed** before returning to the dryer towers.

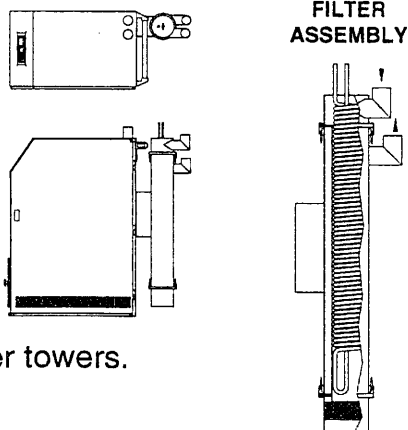

This is accomplished by having the air pass through a plasticizer filter assembly containing a disposable filter element and cooling coil.

The cooling coil condenses the plasticizer out of the vapor where it is trapped by the disposable filter element.

A plasticizer filter is installed in-line between the hopper and the dryer air inlet. The filter access can be serviced by releasing the clamps securing the lid.

9.2 Beds:

Desiccant:

Desiccant and Desiccant Beds - The desiccant is contained within the desiccant beds located internal to the dryer cabinet. The beds should be full of desiccant at all times.

Check the desiccant level occasionally, ensuring the beds are full and the desiccant has not decomposed or discolored (Desiccant is typically light beige in color).

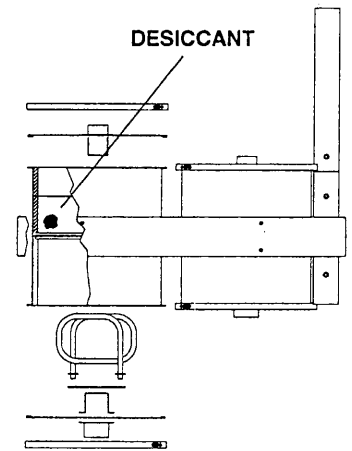

To Check or Change Desiccant

1. Lockout electrical power.
2. Open dryer cabinet.
3. Loosen hose and remove lids to desiccant beds.
4. Remove or check desiccant.
5. Replace insulation if needed and refill with new desiccant, shaking bed to ensure complete filling.
6. Install tower lid and re-attach hose.
7. Close dryer cabinet.
8. Restore electrical power.

WARNING

DESICCANT MAY CAUSE EYE IRRITATION. WEAR EYE PROTECTION. BREATHING DUST MAY BE HARMFUL. OPEN CONTAINER SLOWLY TO AVOID DUST. PROLONGED CONTACT MAY CAUSE SKIN IRRITATION. WEAR GLOVES. USE ADEQUATE VENTILATION. WASH THOROUGHLY AFTER HANDLING. IN CASE OF EYE CONTACT, IMMEDIATELY FLUSH EYES WITH WATER FOR AT LEAST 15 MINUTES. SEE PHYSICIAN IF IRRITATION PERSISTS.

Desiccant Test:

The desiccant (molecular sieve) test outlined is meant to provide only a rough estimate of the residual water level. The procedure is not valid for other types of molecular sieve or for other desiccants.

TEST PROCEDURE - Should be repeated two or more times for most accurate data.

Fill a 150 ml glass beaker with 45 ml (approximately 1.36 oz.) of water.

Measure water temperature and record. The water temperature should not be below 60 degrees Fahrenheit.

Fill a 150 ml glass beaker with 45 ml (approximately 1.36 oz.) of **regenerated** molecular sieve (desiccant may be regenerated using the dryer OR an oven - when using an oven: bake the desiccant at 400 degrees F. (220 C.) for 2 hours and allow to cool to ambient temperatures before proceeding with the desiccant test). It is important that the glass be completely dry before the molecular sieve is added. Even trace moisture will be rapidly adsorbed and give the wrong results.

Dry a thermometer and place it in the beaker with the molecular sieve. Quickly pour the water into

the beaker containing the molecular sieve, as you stir with the thermometer. Record the peak temperature which should be reached in 10-20 seconds. Never add the molecular sieve to water.

Subtract the starting water temperature from the peak temperature of the mixture to get the resulting temperature rise. Next refer to the following graph and find the temperature rise you have measured. Read the corresponding percent of residual moisture. *A residual moisture reading of approximately 5 percent is considered adequate.*

To get the most accurate answer, do the test 2 or more times and take an average of the results. Make sure that the beaker used for the molecular sieve is dried between each test.

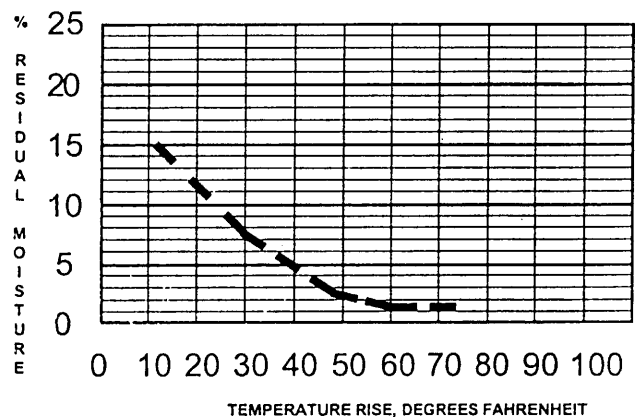

This procedure is designed as a quick method to determine the residual water level of Molecular Sieve Desiccant beads. It is not valid for other adsorbents and desiccants.

Heaters:

Bed (regeneration) Heaters

UDC units utilize sheathed heating elements. Reactivation of desiccant is accomplished by the two bedheaters which alternate "on" and "off" as controlled by the microprocessor. If heaters are not functioning properly, check voltage to the element. If the voltage is correct; check the amperage at the lead wires going to the element.

To Change or Repair a Regeneration Heater:

1. Disconnect power supply.
2. Disconnect heater at electrical terminal located in junction control box.
3. Remove control box if needed. Two bolts at bottom of box secure control box to dryer cabinet. (Note: the control box may be moved aside without disconnecting wiring if need be.)
4. Remove hose and ring clamp from the heater lid.
5. Slide out the entire heater assembly by pulling at the heater lid.
6. Replace insulation as needed.
7. Check amperage of heater after assembly.

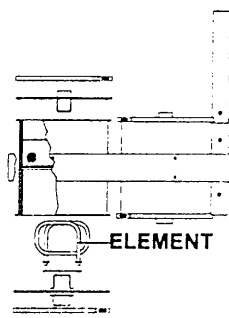

9.3 Process Heater:

The process air entering the hopper is heated by the process(after)heater.

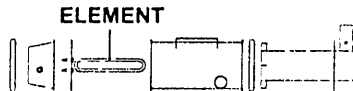

In addition to the process air temperature monitor, the afterheater is regulated by the microprocessor controls. If heaters are not functioning properly, check voltage to the element. If the voltage is correct; check the amperage at the lead wires going to the element.

To Change or Repair a Process Heater

1. Disconnect power supply.
2. Disconnect heater and thermostat leads at electrical terminal located in main control box.
3. Pull connecting wires out of the junction box and remove the bolts from the heater mounting bracket.
4. Pull out the entire heater assembly.
5. Remove V-Band clamp to access heater element.
6. Replace element as needed.
7. Re-install heater and connected heater and thermostat leads.
9. Check amperage of heater after assembly.

9.4 Blower:

A single blower is utilized to supply process and regeneration air to the dryer.

To Change or Repair the Blower Motor

1. Disconnect power supply.
2. Disconnect blower motor leads at electrical terminal located in main control box.
3. Pull connecting wires out of the junction box and remove the bolts from the blower mounting bracket.
4. Pull out the entire blower assembly.
5. Remove control box if needed. Two bolts at bottom of box secure control box to dryer cabinet.
6. Unbolt V-Band clamp to release motor and adapter from filter housing.
7. Repair or replace parts or assemblies as needed.
8. Re-install blower motor and regeneration heater assembly.
9. Check amperage draw after re-starting.

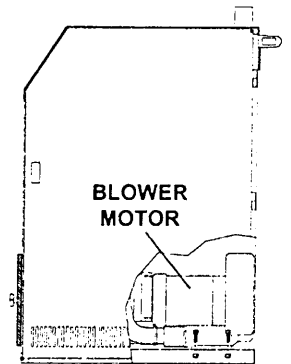

9.5 Dewpoint Sensor:

With time the sensor may degrade, and should be replaced when erratic or questionable behavior is evident. Exposure to volatiles will degrade performance and effect sensor behavior.

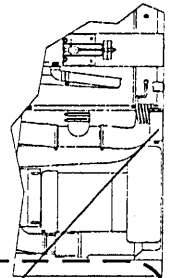

9.6 Printed Circuit Board:

Circuit Boards manufactured by Universal Dynamics Inc. have no customer serviceable parts. No maintenance is required by the customer. In case of damage or defect please consult the factory.

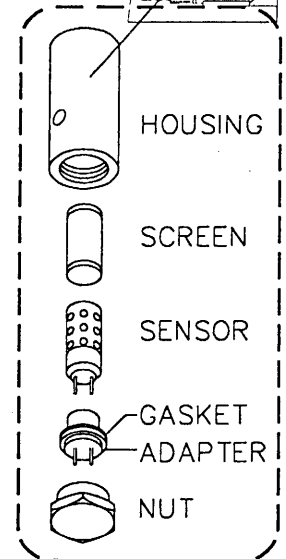

9.7 Contactors: On UDC dryers "mercury" contactors are used for all heaters.

WARNING

THE DRYER MUST BE INSTALLED IN AN UPRIGHT POSITION FOR PROPER OPERATION OF MERCURY CONTACTORS.

9.8 Electrical Disconnect:

The dryer is supplied with a power cord for installation into your power disconnect or attaching a power plug.

Lockout/Tagout procedures must be followed when installing your new UDC model dryer.

WARNING

IT IS IMPERATIVE THAT THE DRYER AND ASSOCIATED ELECTRICAL SYSTEMS BE PROPERLY GROUNDED FOR SAFETY AND FOR PROPER OPERATION OF THE ELECTRONICS.

ELECTRICAL POWER MUST BE DISCONNECTED FROM THE UNIT BEFORE BEGINNING ANY MAINTENANCE. OBSERVE O.S.H.A. LOCKOUT/TAGOUT PROCEDURES. SUGGESTED COMPLIANCE PROCEDURES FOUND IN THE SAFETY APPENDIX.

9.9 Fuses:

Line fuses used on microprocessor controllers are "slow - blow" fuses. This allows for current spikes at initial start-up of components.

Fuses should read 0 Ohms when checked. A very high or "infinite" resistance reading indicates a fuse which is faulty and it should be replaced.

WARNING

REMOVE FUSES FROM PANEL BEFORE CHECKING.

9.10 Changeover "Spool Valve" Assembly:

The changeover "Spool Valve" used on a UDC style dryer is a dependable component. Repair kits are available in the event that a seal becomes damaged, however, customer maintenance is usually not required.

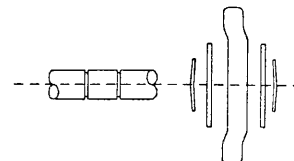
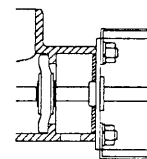

To Change or Repair the Spool Valve

1. Disconnect power supply.
2. Remove actuator cover.
3. Disconnect spool valve motor leads at electrical terminal located in switch box.
4. Pull connecting wires out of the junction box and remove the bolts from the valve mounting bracket.
5. Pull out the entire spool valve assembly.
6. Repair or replace parts or assemblies as needed. Seals can be accessed by removing end plates that are held in place by four bolts.
7. Re-install spool valve assembly.
8. Check for proper air-flow out of Regeneration Port found on rear of the dryer: Valve Position 2 - Air flow from left port. Valve Position 1 - Air flow from right port.

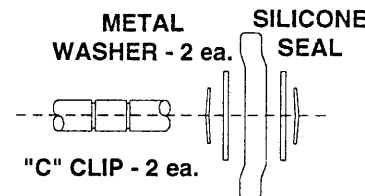

9.11 "Spool Valve" Motor:

The motor for the spool valve is electrically triggered and has no replaceable parts. A signal from the microprocessor controls changeover shift.

To Change or Repair the Spool Valve Motor

1. Disconnect power supply.
2. Remove assembly from brackets.
3. Separate connectors.
4. Pull out the entire spool valve assembly.
5. Repair or replace parts or assemblies as needed.
6. Re-install spool valve assembly.
7. Reinstall electrical wiring; check action of valve motor.
8. Check for proper air-flow out of Regeneration Port found on rear of the dryer: Valve Position 2 - Air flow from left port. Valve Position 1 - Air flow from right port.

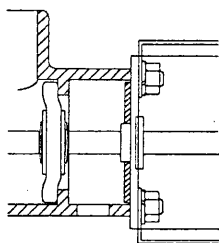

9.13 Output Locations:

J2 Pin #	LED	Relay	Function
1			<i>ac neutral</i>
2	D1	K1	Alarm
3	D2	K2	Valve Position #1
4	D3	K3	Valve Position #2
5	D4	K4	Process Blower
6	D5	K5	Right Regen Heater
7	D6	K6	Left Regen Heater
8	D7	K7	VCL Pump / Blower Motor (or Process Heater #2)
9	D8	K8	Process Heater #1
10			<i>ac hot</i>
J4 Pin #			
1			<i>ac neutral</i>
2	D9	K9	VCL A/B Select (dual VCL only)
3	D10	K10	Ambient/Dry Air Select (dual VCL only)
4			<i>ac hot</i>

Note: All output board relays are rated for maximum of 1 Ampere.

9.12 Thermocouple Sensor Locations:

THERMOCOUPLE NUMBER 1:

Located at Process Heater Number 1 air-stream.

THERMOCOUPLE NUMBER 2:

Located at Process Number 1 Return airstream.

THERMOCOUPLE NUMBER 3:

Spare Number 1 Thermocouple - Used for Process Heater Number 2 air-stream on dual hopper units.

THERMOCOUPLE NUMBER 4:

Spare Number 2 Thermocouple - Used for Process Number 2 Return air-stream on dual hopper units.

THERMOCOUPLE NUMBER 5:

Spare

THERMOCOUPLE NUMBER 6:

Spare

9.14 AC Input Locations:

J2 Pin #	LED	Function
1		<i>ac neutral</i>
2	D4	Blower Pressure Switch
3	D5	not used
4	D6	VCL "B" Level Switch
5	D7	VCL "A" Level Switch
6	D8	Process Filter Switch
7	D9	Hopper 1 Material Low
8	D10	Hopper 2 Material Low
9	D11	Customer Alarm Input
10		<i>not used</i>

9.15 Cabinet Cooling Fan:

Located in the dryer cabinet is a 120 VAC cooling fan. The fan is not serviceable and should be replaced in the event of failure.

To Change the Cabinet Cooling Fan

1. Disconnect power supply.
2. Open dryer cabinet door and disconnect fan leads.
3. Secure fan and remove fan guard from dryer located at rear of cabinet; removing guard will allow fan movement.
4. Remove fan and replace as needed.
5. Re-attach lead wires and replace fan and guard.

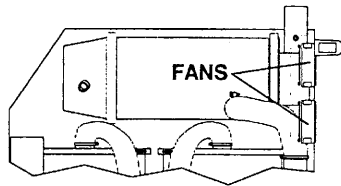

9.16 Setting the Blower Pressure Switch:

Because of the many materials which may be dried with your UNA-DYN® Dehumidifying Dryer, custom setting of the Blower Pressure Switch may be necessary. The following instructions show a method for setting or checking the adjustment of the pressure switch. If you ever see the error message **BLWRFAIL**, and the blower is running, setting your Blower Pressure Switch is necessary.

DANGER

THIS PROCEDURE REQUIRES THAT THE DRYER BE "ON" WHILE ADJUSTING PRESSURE SWITCH; THE ADJUSTMENT SCREW IS ELECTRICALLY "HOT" (110VAC) DURING THIS PROCEDURE. ADJUSTMENT OF THE PRESSURE SWITCH SHOULD ONLY BE PERFORMED BY QUALIFIED OR FACTORY TRAINED PERSONNEL.

STEP 1)

Enter Function 7, press ENTER key. Display will read, **SHUTDOWN**. Press ENTER key. Display will read, **SURE**, press ENTER key. Display will read, **WAIT** for approximately 10 seconds then will read, **SHUTDOWN**. Press CANCEL key twice to continue.

STEP 2)

Enter Function 903, press ENTER key twice. View the Message Window - it will display **0000000**. This indicates that all AC Inputs are "OFF". Open dryer door and locate Blower Pressure Switch. Turn adjustment screw clockwise using an *insulated* screw driver until you see **1000000**. This indicates that the Blower Pressure Switch is being read by the controller as "ON" Turn adjustment screw counterclockwise using an *insulated* screw driver until you again get a display of **0000000**. After completing adjustment, press CANCEL key twice to continue.

STEP 3)

Enter Function 8, press ENTER key twice to continue. Check your adjustment by pressing CANCEL key twice then enter Function 7, as described in Step 2, above. If you do not have a display reading, **1000000** you have not successfully adjusted the Pressure Switch. Press CANCEL key twice to continue. After successfully adjusting Pressure Switch, shut dryer door.

This procedure is illustrated on the rear of this sheet.

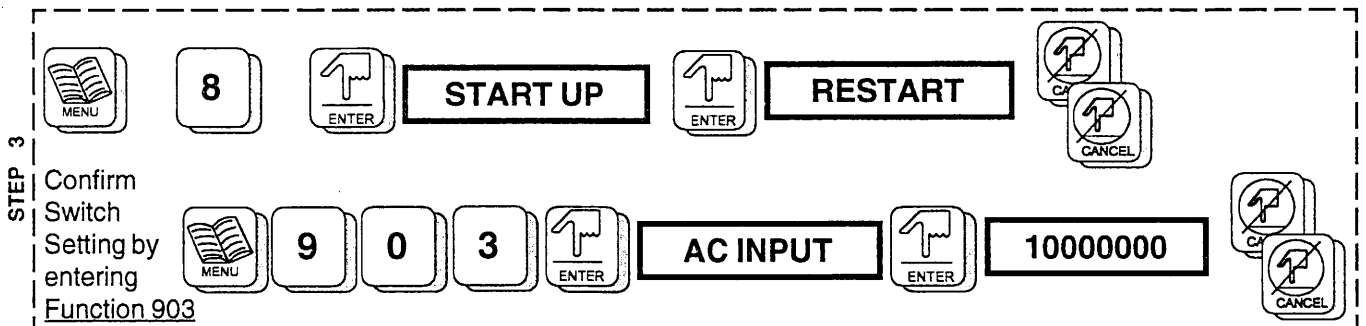
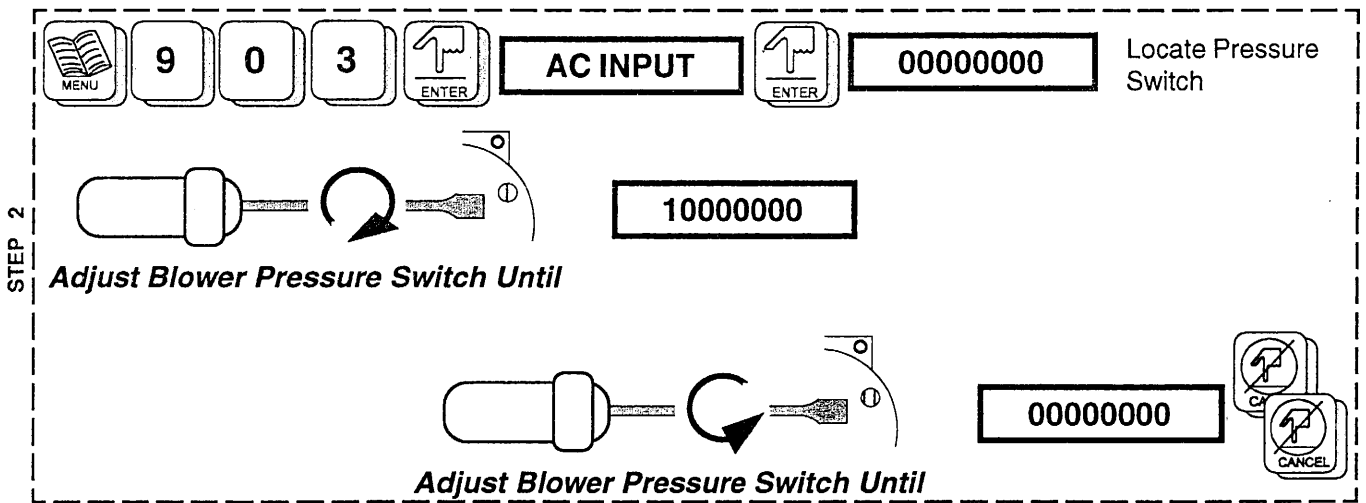
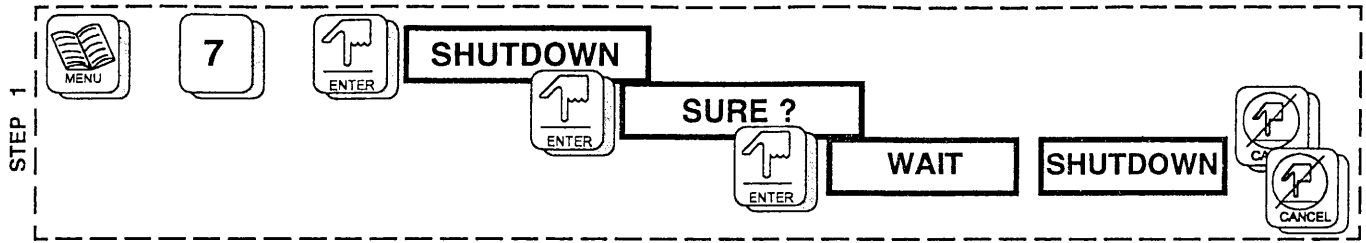

10. VACUUM CLOSED LOOP

Note: All Single Process Heater UDCs support *Single or Dual VCL* operation. Dual Process Heater UDCs do not support any VCL operation.

Vacuum Closed Loop (VCL) - Quick Material Change (QMC) is a system whereby small "shots" of material can be introduced into the processing loop. Actual shot sizes vary, however they are normally based on the concept that the total supply of material at the machine should not exceed **5 shots** or **5 minutes**, whichever is greater. *The normal intent of this system is to Load the Material Drying Hopper with Ambient Air Conveying and the Molding Machine with a Dry Air Conveying Loop.* Note: one of the Material Chambers can dump while the other is loading - this means that if the demand is there and the load times are longer than the dump times for each chamber, the blower could run continuously and that either OR both chambers can be configured to convey with dry air.

The following block diagram may offer some insight into operation.

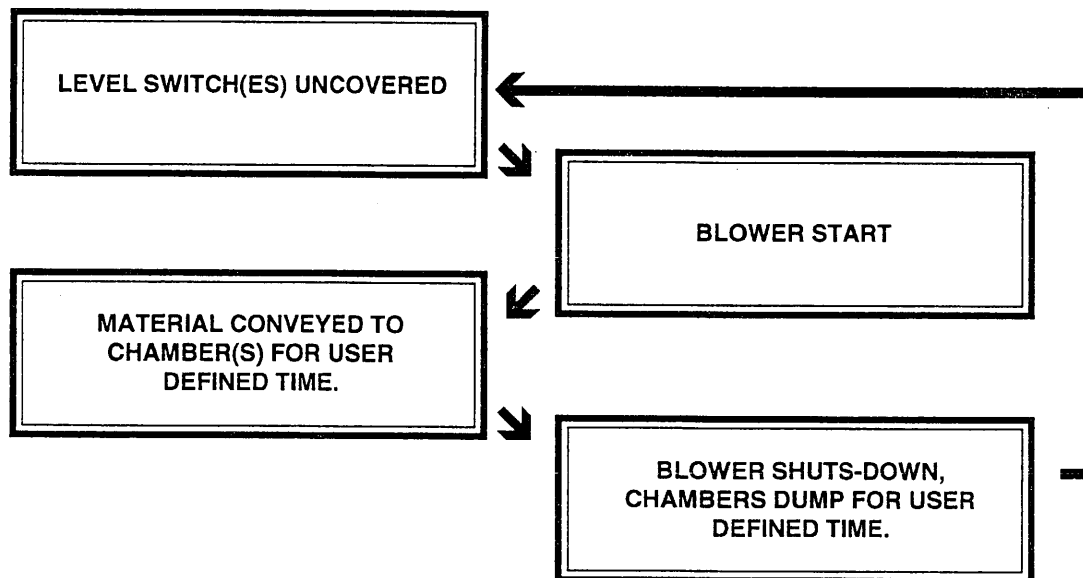

VCL Chamber Level Switches are normally closed, therefore, when material is covering the Level Switch the system is ready and waiting with available material. As the Level Switch is uncovered the blower begins to *load* (material is *vacuum conveyed* to the selected VCL Material Chamber(s)) for the user specified load time (function 132/142). After the specified load time the system then *dumps* the material; also for a user specified dump time (function 133/143).

Typical System Diagram:

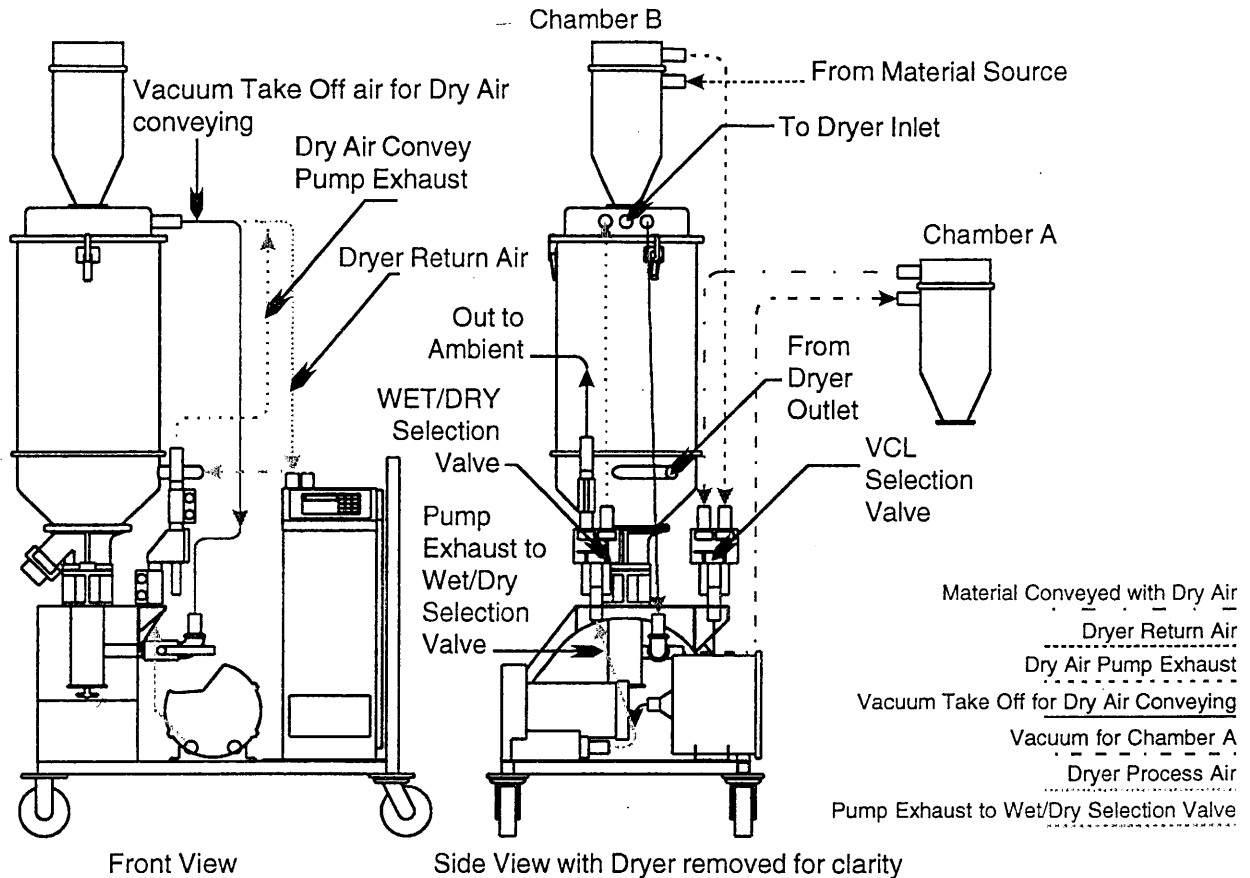

CAUTION

YOU MUST ADJUST THE VACUUM TAKE-OFF AND VCL CHAMBER-LEVEL SWITCH(ES) FOR YOUR SPECIFIC MATERIAL NEEDS.

1. VACUUM TAKEOFF: These adjustments are based on the amount of air allowed in to fluidize the material for conveying. Make this adjustment while the unit is moving material if possible. Rotate the ball valve to increase or decrease the amount of air.

2. VCL CHAMBER LEVEL SWITCH: There is an LED indicator light on the rear of the switch. This LED is *ON* when material is called for, and loading is taking place. When the material level is satisfactory the LED is *OFF*. You will adjust the sensitivity of the level switch so that it recognizes material in the glass tube and ceases to load when material is present.

To adjust the sensitivity of the switch:

1. Position the switch approximately .0001" (approximately the thickness of a match book cover or business card) from the glass tube.
2. Remove the black screw covering the adjustment slot.
3. Slowly turn the adjustment slot counterclockwise to cause the LED to come *ON* (this would enable material loading). After the LED just lights, continue to turn the slot another 1/4 to 1/2 turn counter clockwise.
4. Now check sensitivity by placing a feeler gauge, at the front of the level switch. The LED indicator light should immediately go *OFF*.
5. Confirm operation of level switch; readjust if necessary. In rare instances the distance from the level switch to the glass tube must be decreased.
6. *After confirming adjustment* replace the black screw which covered the adjustment slot. Periodically check your adjustment.

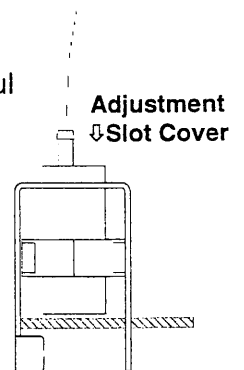

Function 114: VCL A [Set VCL A System Parameters]

After gaining access to Function 114 (you may use any of the methods discussed in Section 8.1- pages 15 to 17), press the Menu key to continue or you may enter directly by using the appropriate Function Code. Repeated pressing of the Menu key scrolls you through the following available functions:

- Function 131 — ON or OFF or ON/SHDN
- Function 132 — LOADTIME
- Function 133 — DUMPTIME
- Function 134 — DRY/AMB (*Requires OPTIONAL VCL Vacuum Pump Exhaust Diverter Valve - Standard with Dual VCL System*)

This function (Function 131) is used to enable or disable the VCL function. Repeated pressing of the Menu key scrolls you through the OFF - ON - ON/SHDN. The ON/SHDN selection allows the VCL to operate when the dryer is powered but OFF.

Note: If Vacuum Closed Loop is "enabled" for operation during shutdown mode the Message Window will display:

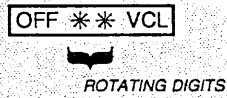

Note that the factory default setting for this function is "ON".

Use the Menu key to toggle between Enable (ON), Disable (OFF) and Enabled with the dryer "off" but with power still supplied (ON/SHDN). When the system is set to your preference press the Enter key to save the setting. Press the Menu key to toggle to the next selection: *Load Time*.

This function (Function 132 — LOADTIME) sets the load time for the individual chamber. The minimum value is 1 second and the maximum value is 255 seconds. Note that the factory default setting is 8 seconds.

Press the Enter key to step to the number entry, then use the Numbered keys to set the desired load time and press the Enter key to save the setting.

Press the Menu key to toggle to the next selection: *Dump Time*.

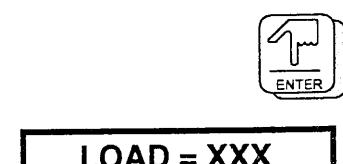
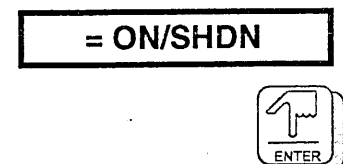
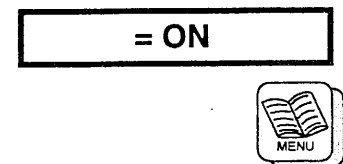
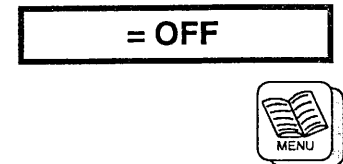
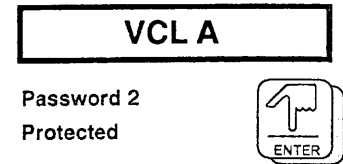

XXX being the current setting.

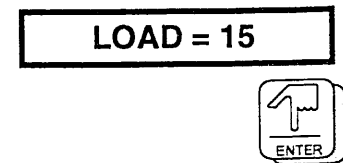

This function (Function 133 — DUMPTIME) sets the dump time for the individual chamber. The minimum value is 1 second and the maximum value is 255 seconds. *Note that the factory default setting is 10 seconds.*

Press the Enter key to step to the number entry, then use the Numbered keys to set the desired load time and press the Enter key to save the setting. Press the Menu key to toggle to the next selection: *VCL A - DRY/AMB.*

This function (Function 134 — DRY/AMB) tells the controller whether the material is being conveyed with ambient or dry air. With this knowledge the controller will position the dry/ambient diverter valve to either return the conveying air to the drying system (if DRY is selected) or to atmosphere (if AMB is selected). Press the Enter key to save the setting. *Note that the factory default setting is DRY.*

Repeated pressing of the Cancel key steps you back out through the Function Code Tree.

DUMPTIME



DUMP = XXX

XXX being the current setting.



DUMP = 5



DRY/AMB



AIR = DRY



AIR = AMB



Password Level 2 Protected

Function 115: VCL B - Optional Second VCL Chamber [Set VCL B System Parameters]

Note: if your system utilizes only one chamber entries made here will not affect the VCL A function.

After gaining access to Function 115 (you may use any of the methods discussed in Section 8.1- pages 15 to 17), press the Menu key to continue or you may enter directly by using the appropriate Function Code. Repeated pressing of the Menu key scrolls you through the following available functions:

- Function 141 — ON or OFF or ON/SHDN
- Function 142 — LOADTIME
- Function 143 — DUMPTIME
- Function 144 — DRY/AMB

This function (Function 141) is used to enable or disable the VCL function. Repeated pressing of the Menu key scrolls you through the OFF - ON - ON/SHDN. The ON/SHDN selection allows the VCL to operate when the dryer is powered but OFF.

Note: If Vacuum Closed Loop is "enabled" for operation during shutdown mode the Message Window will display:

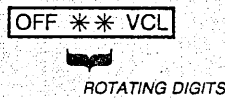

Note that the factory default setting for this function is "ON".

Use the Menu key to toggle between Enable (ON), Disable (OFF) and Enabled with the dryer "off" but with power still supplied (ON/SHDN). When the system is set to your preference press the Enter key to save the setting. Press the Menu key to toggle to the next selection: *Load Time*.

This function (Function 142 — LOADTIME) sets the load time for the individual chamber. The minimum value is 1 second and the maximum value is 255 seconds. Note that the factory default setting is 10 seconds.

Press the Enter key to step to the number entry, then use the Numbered keys to set the desired load time and press the Enter key to save the setting.

Press the Menu key to toggle to the next selection: *Dump Time*.



Password 2 Protected

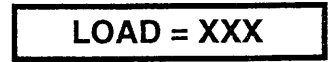
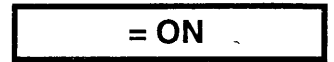

XXX being the current setting.



This function (Function 143 — DUMPTIME) sets the dump time for the individual chamber. The minimum value is 1 second and the maximum value is 255 seconds. *Note that the factory default setting is 10 seconds.*

Press the Enter key to step to the number entry, then use the Numbered keys to set the desired load time and press the Enter key to save the setting. Press the Menu key to toggle to the next selection: *VCL B - DRY/AMB.*

This function (Function 144 — DRY/AMB) tells the controller whether the material is being conveyed with ambient or dry air. With this knowledge the controller will position the dry/ambient diverter valve to either return the conveying air to the drying system (if DRY is selected) or to atmosphere (if AMB is selected). Press the Enter key to save the setting. *Note that the factory default setting is AMB.*

Repeated pressing of the Cancel key steps you back out through the Function Code Tree.

DUMPTIME



DUMP = XXX

XXX being the current setting.

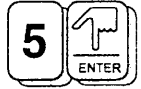

DUMP = 5



DRY/AMB



AIR = AMB



AIR = DRY



Run Time Diagnostics for UDC Dryers with Dual Chamber VCL Systems:

Function 121 — RUN DIAG

- Func 901 — LAMPTEST
- Func 902 — KEYPAD
- Func 903 — AC INPUT
- Func 904 — DIPSWITCH
- Func 905 — PROCESS1
- Func 906 — RETURN 1
- Func 907 — SPARE 1 (or PROCESS2 for dual heater units)
- Func 908 — SPARE 2 (or RETURN 2 for dual heater units)
- Func 909 — SPARE 3 (or SPARE 1 for dual heater units)
- Func 910 — SPARE 4 (or SPARE 2 for dual heater units)
- Func 911 — DEW DIAG
- Func 912 — VCL DIAG
- Func 913 — UNIT ID
- Func 914 — ADV CAM

Output Tests for UDC Dryers with Dual Chamber VCL Systems:

OUTPUTS

- PROCBLWR
- L BED HT
- R BED HT
- VALVE 1
- VALVE 2
- PROC HTR
- VCL BLWR
- VCL A/B
- VCL AIR
- ALARMOUT

Dual VCL Diagnostics:

Function 912 — VCL DIAG

Press the Enter key to continue and the Message Window will display the status of the VCL inputs and outputs via this diagnostics function. A typical display for this function is:

M— S A W

*Note: if this function is selected on 2-heater UDC the Message Window will display: **NOTAVAIL***

The first letter in the display (M in example above) reflects the VCL A material level input as seen by the controller. An "M" indicates that material is detected at the level switch, whereas a display of "—" would indicate that NO material is detected at the level switch.

The second letter in the display (— in example above) reflects the VCL B material level input as seen by the controller. This example indicates that NO material is detected at the level switch.

The third letter in the display (S in example above) reflects the status of the VCL blower; either "stopped" (indicated by an S) or "running" (indicated by an R).

The fourth letter in the display (A in example above) reflects the position of the Vacuum Diverter Valve, which is either in the "VCL A" position (indicated by an A) or the "VCL B" position (indicated by a B).

The fifth letter in the display (W in example above) reflects the position of the Blower Exhaust Diverter Valve, which is either in the "ambient" position to exhaust to atmosphere (indicated by a W (wet) in example above) or is in the "dry" position to exhaust back into the drying system (indicated by a D).

Dual VCL Pinouts:

FNX Main

- J5 pin 5: VCL A material level input (LED D7) — When input de-energized, material present
- J5 pin 4: VCL B material level input (LED D6) — When input de-energized, material present

FN Output

- J2 pin 8: Vacuum Blower ON/OFF (LED D7) — Energizes output to run blower
- J4 pin 2: Chamber A/B select (position vacuum side diverter valve) (LED D9) — De-energized for Chamber A; Energized for Chamber B
- J2 pin 3: Dry/Ambient diverter valve (LED D10) — De-energized for ambient position; Energized for dry position.

11. MULTI-HOPPER SYSTEM

11.1. Optimizing Air Flow:

This may be accomplished by using a measurement device to check each individual hopper in the system.

Devices available for measurement of air velocity thru the system could include either a portable or permanent air velocity meter.

A **PITOT TUBE** or **HOT WIRE ANEMOMETER** are logical choices.

Hoppers are ordered for a system such as this with specific drying capabilities requested. There is no "hard and fast rule" on how the air flow will be distributed in the system. When smaller and larger hoppers are grouped together, naturally, a smaller hopper will have less air volume thru it than a larger hopper.

An *approximate balance* may be made by monitoring hopper temperature; equalize hopper inlet temperature and monitor hopper outlet temperature to judge airflow balance. *Equal size hoppers should have air divided equally to all hoppers with the same material level present in each.*

CAUTION

MULTI-HOPPER SYSTEMS WITH MORE THAN 2 HOPPERS SHOULD HAVE A LEAST 50% OF THE TOTAL HOPPERS ON-LINE AT ANY ONE TIME TO PREVENT EXCESS AIRFLOW WITHIN REMAINING HOPPERS IN THE SYSTEM.

Adjust airflow as hopper material level is reduced. A partially filled hoppers runs a higher airflow than a full hopper because of decreased back pressure. This increased airflow thru only part of the system will deprive other hoppers in the system of adequate airflow.

CAUTION

YOU MUST TAKE OFF-LINE ANY HOPPER BEING OPENED FOR SERVICE OR CLEANING BY CLOSING VALVES OR DAMPERS. AN EMPTY HOPPER LEFT ON-LINE ROBS OTHER HOPPERS IN THE MULTI-HOPPER SYSTEM OF AIRFLOW.

11.2. Adjustable Valves:

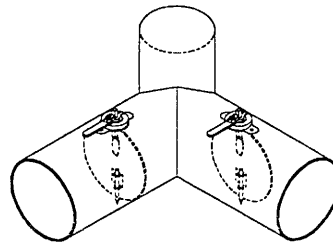

DAMPER - SHOWN WITH ONE PORT CLOSED TO RESTRICT AIR FLOW AND ONE PORT OPEN FOR FREE AIR FLOW

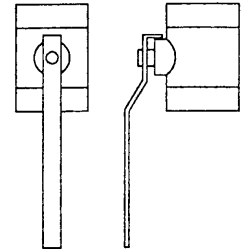

BALL VALVE - TOP AND SIDE VIEW FOR CLARITY

Devices available for restricting air flow into the hopper could include **dampers** or **ball valves**. Either choice will enable the operator to adjust airflow into or out-of the hopper.

WARNING

VALVE AND/OR DAMPER HANDLES MAY BE HOT TO THE TOUCH. USE APPROPRIATE PROTECTIVE EQUIPMENT WHEN OPERATING VALVES OR DAMPERS.

11.3. Manifold:

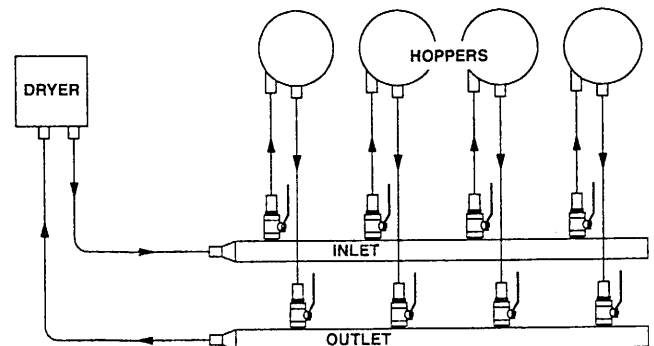

To insure complete flexibility when setting-up a multi-hopper system a *manifold* may be used. This allows operators to close-off an air inlet on an empty vessel, or completely isolate with minimum delay, a hopper from the system by closing the air inlet and outlet.

11.4. Configurations Available:

There are 3 basic configurations available:

- Two or More Hoppers with adjustable valves.
- Two or More Hoppers with adjustable valves; process air heater with adjustable individual temperature controls.
- Two or More Hoppers with adjustable valves; process air heater with adjustable individual temperature controls; process air blower for each individual hopper.

WARNING

SYSTEMS WITH HOPPER MOUNTED BLOWERS MUST HAVE CHECK VALVES OR OTHER AUTOMATIC ISOLATION VALVES TO PREVENT INCORRECT AIRFLOW THROUGH AN UNUSED HOPPER.

11.4-A Two or More Hoppers with Adjustable Valves:

Very simple and straightforward. You must balance the supplying airflow to the number of hoppers, hopper size and material thruput requirements.

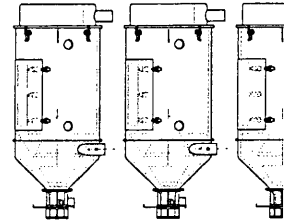

11.4-B Two or More Hoppers with Adjustable Valves and Process Heater:

Balance the supplying airflow to the number of hoppers, hopper size and adjust Process Air Heater at hopper to material drying requirements.

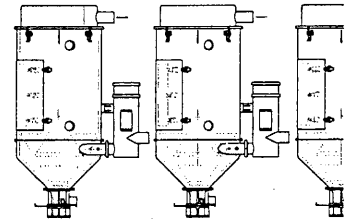

CAUTION

WHEN AN INDEPENDENT PROCESS AIR HEATER, WITH TEMPERATURE CONTROL IS MOUNTED TO THE HOPPER, THE SETPOINT OF THE MICROPROCESSOR CONTROLLER MUST BE SET TO 32 DEGREE FAHRENHEIT (0 DEGREES CENTIGRADE) TO PREVENT UNNECESSARY ALARM INDICATIONS AT DRYER CONTROLLER.

NOTE: The F/N Controller will successfully control 1 or 2 process heaters. If more than 2 process heaters are to be used individual controls for each process heater will be supplied at the hopper.

11.4-C Two or More Hoppers with Adjustable Valves, Process Heater and Process Blower:

Adjust Process Air Setpoint and modulate Process Air-Flow to each individual hopper.

WARNING

HOPPERS WHICH HAVE INDEPENDENT PROCESS AIR HEATERS *MUST* HAVE ADEQUATE AIRFLOW TO PREVENT PREMATURE FAILURE OF THE HEATERS. OPERATORS MUST VERIFY PROPER AIR BALANCE BEFORE ELEVATING TEMPERATURE CONTROL ON HOPPER PROCESS AIR HEATER.

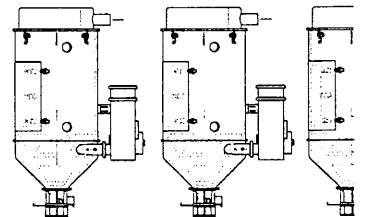

NOTE: The F/N Controller will successfully control 1 or 2 process heaters. Typically if more than 2 process heaters are to be used individual controls for each process heater will be supplied at the hopper.

12. TROUBLE SHOOTING

WHENEVER YOU ARE CALLING UNIVERSAL DYNAMICS ABOUT YOUR MACHINE, PLEASE HAVE THE MACHINE SERIAL NUMBER, S. O. NUMBER (LOCATED ON TITLE PAGE OF MANUAL AND ON MACHINE IDENTIFICATION PLATE ATTACHED TO DRYER FRONT DOOR) AND THE SOFTWARE VERSION NUMBER AVAILABLE SINCE ALL RECORDS ARE FILED UNDER THESE NUMBERS. CONTACT THE SERVICE DEPARTMENT BY TELEPHONE AT 703.491.2191 OR VIA FAX AT 703.491.6898.

The following guide may be of use in Trouble Shooting the unit and will prove invaluable when contacting the Service Department:

MACHINE SERIAL NUMBER: _____

SOFTWARE VERSION NUMBER: _____

ACTUAL VOLTAGE BEING APPLIED: _____

NAME PLATE VOLTAGE: _____

AMPERAGE WITH AFTERHEATER ON: _____

AMPERAGE READINGS AT:

LEFT BED: _____ RIGHT BED: _____

AFTER HEATER: _____ MOTOR: _____

SIZE OF HOPPER BEING USED: _____

TEMPERATURE AT HOPPER INLET: _____

RETURN AIR TEMPERATURE FROM HOPPER: _____

TEMPERATURE AT CHANGEOVER: _____

CAM CELL(S) PROBLEM OCCURS IN: _____

ALARM BEING DISPLAYED: _____

MATERIAL BEING DRIED: _____

THRUPUT IN LBS./HR.: _____

DEWPOINT BEING INDICATED IN SYSTEM: _____

SYMPTOM

DRYER WILL NOT START

POSSIBLE CAUSE

1. Faulty connection at power cable.
2. Wiring incorrect.
3. Defective fuses.
4. Mis-set or defective Pressure Switch.
5. Dryer shows "off" and "idle" display.

POSSIBLE SOLUTION

1. Check connection reattach to cable as needed.
2. Check wiring; correct if needed.
3. Replace.
4. Reset, repair or replace as needed.
5. External Shutdown Input activated. Use Function 8 and check AC Input status.

POOR DEWPOINT

POSSIBLE CAUSE

1. Bed (Regen) heater(s) defective.
2. High-Temp connection failure.
3. System overloaded by "wet" material.
4. Desiccant defective.
5. Leaks in the system.
6. Poor air flow.
7. Valve not switching.
8. Return air temperature too high.
9. Dewpoint instrument not functioning correctly.
10. Defective bed heater contactor.

POSSIBLE SOLUTION

1. Check amperage on heater. Repair or replace. Check fuses and repair or replace.
2. Replace using proper High-temp connector and installation tools.
3. Test material for moisture content from supplier. Dry Cycle dryer one time sequence to purge system of excess moisture load.
4. Perform desiccant check.
5. Check all hose connections and tighten hose clamps.
6. Check filter and spreader cone for free air flow.
7. Check operation of changeover cylinder/motor. Repair or replace as needed.
8. Check return air temperature; should be less than 125 degrees F. (50 degrees C.) Optional precooling coil may be necessary.
9. Check dewpoint with another instrument to confirm actual dewpoint. Check sample cell for positive air flow. Test sensor by placing in ambient and view readings (should read +15 or more). Test cable by unplugging from sensor and view reading (should read approximately -40). Test cable by removing from board and view reading (should read again read -40).
10. Check contactor for operation. Replace as needed.

UNDERTEMPERATURE ALARM / UNDER TEMP 1 OR 2

POSSIBLE CAUSE	POSSIBLE SOLUTION
1. No or low air flow on return air lines.	1. Check filters and spreader cone for free air flow. Air must circulate past the process heater thermocouple.
2. Heater failure.	2. Check process heater amperage.
3. Contactor failure.	3. Check for pitting and burns; replace as needed.
4. Process heater fuses defective.	4. Replace.
5. Insulated hose defective.	5. Repair or replace as needed.
6. Thermocouple not properly installed in airstream.	6. Check placement of Thermocouple; change as needed.

INSUFFICIENT AIR FLOW

POSSIBLE CAUSE	POSSIBLE SOLUTION
1. Dirty filters.	1. Clean; replace as needed.
2. Defective blower motor.	2. Check blower; correct as needed.
3. Dirty blower wheel.	3. Clean.
4. Obstructed air lines.	4. Remove obstruction.
5. Spreader cone clogged.	5. Clean.
6. Leaks in system.	6. Check all hosing and gasketing; tighten hose clamps as needed. Check loading system supplying hopper for leaks.
7. Mis-set or defective Pressure Switch.	7. Reset, repair or replace as needed.

HEATER FAILURE

POSSIBLE CAUSE	POSSIBLE SOLUTION
1. Defective fuses.	1. Replace.
2. Defective heater element(s).	2. Repair if possible; replace if needed.
3. High-Temp connection failure.	3. Replace using proper High-temp connector and installation tools.
4. Short in High-Temp lead wires.	4. Replace as needed.
5. Mis-set or defective Pressure Switch.	5. Replace heater element as needed.

NO PROCESS HEAT

POSSIBLE CAUSE	POSSIBLE SOLUTION
1. Process (After) heater defective.	1. Check amperage on heater. Replace as needed.
2. Setpoint too low or set to 32° F.	2. Adjust.
3. Thermocouple defective or mis-wired.	3. Check connections. Lower setpoint to 32 degrees F. (0 C.) and see if Thermocouple reads ambient; apply heat to sensor and see if follows temperature.

TEMPERATURE TOO HIGH IN HOPPER

POSSIBLE CAUSE

1. Thermocouple defective or mis-wired.
2. Valves not switching.
3. Return air temperature too high.
4. Mis-set or defective Pressure Switch.

POSSIBLE SOLUTION

1. Check connections. Lower setpoint to 32 degrees F. (0 C.) and remove from process air flow - see if Thermocouple reads ambient; apply heat to sensor tip and see if follows temperature.
2. Check operation of changeover cylinder/motor. Repair or replace as needed.
3. Check return air temperature. Optional precooling coil may be required.
4. Reset, repair or replace as needed.

PROCESS OVERTEMPERATURE ALARM / OVER TEMP 1 OR 2

POSSIBLE CAUSE

1. Dirty Filters.
2. Dirty blower wheel.
3. Failed heater contactor.
4. Hopper air inlet filled with material causing excessive back pressure.
5. Too sharp a bend in air supply hose to hopper causing excessive back pressure.
6. Defective blower motor
7. Thermocouple defective.
8. Valve defective.
9. Mis-set or defective Pressure Switch.

POSSIBLE SOLUTION

1. Clean or replace.
2. Clean.
3. Replace.
4. Check spreader cone for correct seating. Remove any material buildup at hopper air inlet.
5. Remove sharp bend in air lines.
6. Check amperage of blower motor.
7. Check connections. Lower setpoint to 32 degrees F. (0 C.) and remove from process air flow - see if Thermocouple reads ambient; apply heat to sensor and see if follows temperature.
8. Check operation of c/o cylinder/motor. Repair or replace as needed.
9. Reset, repair or replace as needed.

THERMOCOUPLE ERROR / SENSERR 1 OR 2

POSSIBLE CAUSE

1. Defective thermocouple.
2. Connection failure.
3. Thermocouple out of airstream

POSSIBLE SOLUTION

1. Repair or replace as required.
2. Replace using proper connector and installation tools.
3. Check placement of thermocouple.

BLOWER FAILURE / BLWRFAIL

POSSIBLE CAUSE	POSSIBLE SOLUTION
1. Defective blower.	1. Repair or replace as required.
2. Connection failure.	2. Replace using proper connector and installation tools.
3. Pressure sensor defective.	3. Repair or replace as required.
4. Pressure sensor out of adjustment.	4. Adjust using procedure found on page 60.

VALVE NOT MOVING/SEALING

POSSIBLE CAUSE	POSSIBLE SOLUTION
1. Defective Valve Motor.	1. Repair or replace as required.
2. Defective Valve Shaft "Screw".	2. Repair or replace as required.
3. Defective wiring.	3. Repair or replace as required.

CLOCK ERROR

POSSIBLE CAUSE	POSSIBLE SOLUTION
1. Voltage spike to controller.	1. Clear any system alarms.
2. Defective "timer-keeper" chip.	2. Reset clock; if problem persists contact Factory for NVRAM chip replacement.

NV RAM

POSSIBLE CAUSE	POSSIBLE SOLUTION
1. Voltage spike to controller.	1. Clear any system alarms.
2. Defective NVRAM "timekeeper".	2. Reset clock; if problem persists contact Factory for NVRAM chip replacement.
3. Software Version Change.	3. When new/different software is installed the controller reverts to the Factory Defaults and indicates this by reporting an "NVRFAIL" alarm.

MAIN BOARD REPLACEMENT:

1. Disconnect power to dryer.
2. Open dryer cabinet door.
3. Remove cover from controller box via four screws.
4. Remove all power from control box.
5. Remove the two 7/16" bolts from the bottom of controller box and two lock-washers and nuts from under the control box.
6. *Gently* tilt the controller box down at an angle that allows you to reach the three 5/16" nuts that are holding down the Main Board.
7. Remove the 5/16" nuts that hold the cover to the top of the Main Board.
8. Remove the three standoffs that secure the Main Board to the controller box. Now remove all the connectors from the Main Board (there may be up to six connectors).
9. Remove the Main Board from the controller box. Use caution unplugging the optical cable.
10. Insert the new Main Board and install it reversing the procedure above.
Note: Do not pull on cable; use small screwdriver to push from socket location.

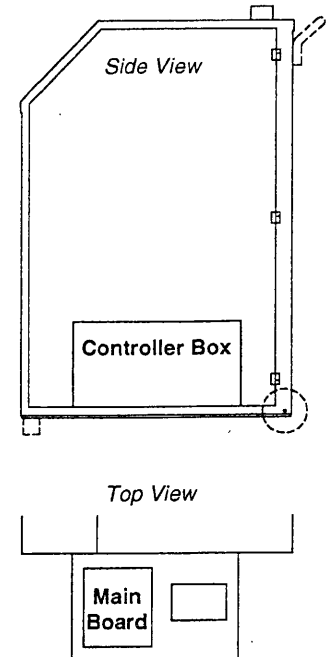

FIRMWARE REPLACEMENT:

The firmware chip is located on the Main Board

1. Disconnect power to dryer.
2. Open dryer cabinet door.
3. Remove cover from controller box via four screws.
4. Remove all power from control box.
5. Remove the two 7/16" bolts from the bottom of controller box and two lock-washers and nuts from under the control box.
6. *Gently* tilt the controller box down at an angle that allows you to reach the three 5/16" nuts that are holding down the Main Board.
7. Remove the 5/16" nuts that hold the cover to the top of the Main Board.
8. Remove the old firmware chip- **U3 (Note Alignment Notch)**.
9. Insert the new firmware chip (**Note Alignment Notch**) and assemble reversing the procedure above.

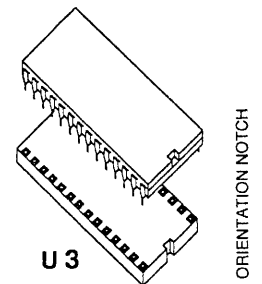

"TIMEKEEPER" CHIP REPLACEMENT:

The "timekeeper" chip is located on the Main Board

1. Disconnect power to dryer.
2. Open dryer cabinet door.
3. Remove cover from controller box via four screws.
4. Remove all power from control box.
5. Remove the two 7/16" bolts from the bottom of controller box and two lock-washers and nuts from under the control box.
6. *Gently* tilt the controller box down at an angle that allows you to reach the three 5/16" nuts that are holding down the Main Board.
7. Remove the 5/16" nuts that hold the cover to the top of the Main Board.
8. Remove the old "timekeeper" chip- **U4 (Note Alignment Notch/Dot)**.
9. Insert the new "timekeeper" chip (**Note Alignment Notch/Dot**) and assemble reversing the procedure above.

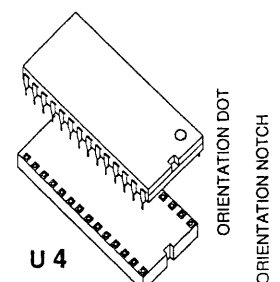

Entering FN Service Mode

Step 1: Press the Menu Push-button then enter Function Code 101 using the Numbered Push-button. Press the Enter Push-button. The display will read "PAS SET".

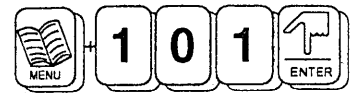

PAS SET



Step 2: Press the Enter Push-button. The display will read "PAS2"

PAS 2



Step 3: Press the View Alarm Push-button. The display will continue to read "PAS2". This is asking you for password #2. DO NOT ENTER YOUR PASSWORD 2!!

PAS 2

Step 4: Enter in 2191 using the Numbered Push-button. Stars will be displayed as you type in the numbers. When the fourth digit is entered the display will change to read "SERVMODE". You are now in Service Mode.

2 1 9 1

* * * *

Step 5: Press the Cancel Push-button repeatedly until the display reads the temperature and dewpoint.



TEMP DEWPT

Note: After 4 minutes Service Mode will automatically disable itself.

CAUTION

SERVICE MODE DISABLES ALL PASSWORDS WHILE IT IS ENABLED. WHEN SERVICE MODE IS DISABLED THE PASSWORDS ARE RESTORED.

Changing Your Password

Changing Password Level 1

Step 1: After entering "Service Mode" (see previous page) press the Cancel Push-button repeatedly until the display reads the temperature and dewpoint in the controller's message window.



TEMP DEWPT

Step 2: Press the Function Push-button then enter Function Code 102 using the Numbered Push-buttons.



PASSWD1

Press the Enter Push-button. The display will read "PASSWD1".



NEW 1

Step 3: Press the Enter Push-button. The display will read "NEW1

Step 4: Enter your new four digit password (for example - 3333). Stars will appear as you press the number keys.

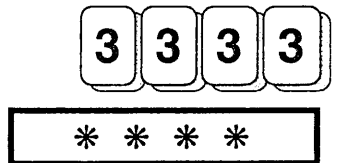

Step 5: Press the Enter Push-button. The display will read "CONFIRM". Re-Enter your new password.



CONFIRM

Step 6: Press the Enter Push-button to save this password.

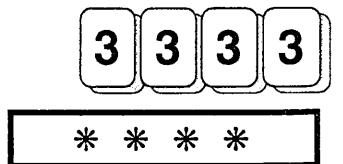

Changing Password Level 2

Same as changing Password Level 1 except you use Function 103.



PASSWD2

13. SERVICE INFORMATION:

13.1 Warranty Parts Covered:

We at UNA-DYN believe our equipment to be the finest drying systems you can purchase, and back this up with a 12 month warranty on our equipment.

We supply warranty parts through UPS ground transportation when possible. In the event that an item is too large for UPS, we use the quickest truck shipper available.

Items which are not ordinarily stocked will be "drop-shipped" when possible.

Manufactured parts are produced for customers as quickly as possible. Many times we can have a needed manufactured PC Board shipped within 24 hours. Sheet metal assemblies are produced under the constraints of a busy manufacturing facility.

One day delivery by UPS and Federal Express of some parts is available at customer cost.

Expendable items such as filters, contactors, motor starters and contaminated desiccant are exempt.

13.2 Returning Items for Repair:

Items may be returned to the factory for repair by qualified Service Technicians. Please call the plant at 703-491.2191 for a Returned Goods Authorization (RGA) Number. Parts returned without a RGA number may be delayed in processing.

The minimum charge for in-house Service Repairs will quite frequently cover most repairs needed on P.C. Boards. Please consult the factory for our current minimum billing.

13.3 Telephone Service:

A team of Telephone Service people can be reached via telephone at 703.491.2191 OR you may fax your service questions to 703.491.6898, attention Service Department Manager.

13.4 Field Service:

Scheduling and cost for services listed below may be obtained from the Field Service Manager.

Field Service can be available for travel to your plant. These important members of Una-Dyn are available for:

1. Start - Up of Drying System: Our Service people will do a "start-up" procedure in your plant. This would consist of checking field wiring and connections, start-up and troubleshooting of a new system.
2. Repair equipment in the customer's facility. Both warranty and non-warranty repairs can be arranged.
3. Instruction classes for all personnel can be arranged. These can be scheduled in our "Educational Center" here in Woodbridge, VA, or in the customer's plant. These classes have proven invaluable to our customers in the past. Complete instruction on maintenance, control operation, system theory, etc. are available.

USER'S COMMENTS FORM

Document: UDC 100/150 SERIES DRYERS WITH FN CONTROLLER [v 1.30 - r0]

Please suggest improvements to this manual: _____

Please list any errors in this manual on the reverse side of this sheet. Specify by page.

FOLD HERE FIRST



FROM:

Name _____ Title _____

Company _____

Address _____

Date: _____ Business Phone No.: _____

FOLD HERE

Tape edges for mailing - please do not use staples



NO POSTAGE
NECESSARY
IF MAILED
IN THE
UNITED STATES

BUSINESS REPLY MAIL
FIRST CLASS PERMIT NO. 40 WOODBRIDGE, VA
POSTAGE WILL BE PAID BY ADDRESSEE

Universal Dynamics, Inc.

A Company of MANN+HUMMEL ProTec

P. O. Drawer X

Woodbridge, VA 22194-0396

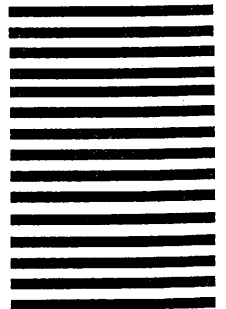

Attn.: Godwin

UNIVERSAL DYNAMICS, INC.
A Company of the MANN+HUMMEL Group
Woodbridge, Virginia
STANDARD CONDITIONS OF SALE

1. **UNIVERSAL DYNAMICS, INC.**, (henceforth referred to as **UNA-DYN**, or the **COMPANY**) guarantees that its products are free from defects in materials and workmanship, and that if, within one year from date of shipment thereof, any guaranteed product should fail for the foregoing reasons, **UNA-DYN** will replace or repair such product free of charge under conditions described herein.

UNA-DYN does not guarantee the performance of any product except as may be expressly stated to the contrary in the applicable quotation or other documents of which these conditions are a part.

Guarantees of products not manufactured by **UNA-DYN**, including purchased components, shall be limited to the guarantees and warranties of the respective manufacturers.

THE WARRANTIES, OBLIGATIONS AND LIABILITIES OF **UNA-DYN** SET FORTH HEREIN ARE EXCLUSIVE AND IN SUBSTITUTION FOR ALL OTHER WARRANTIES, OBLIGATIONS AND LIABILITIES OF **UNA-DYN**. EXPRESS OR IMPLIED, INCLUDING THE IMPLIED WARRANTY OF FITNESS FOR A PARTICULAR PURPOSE. WITH RESPECT TO ANY NON-CONFORMANCE OR DEFECT IN PRODUCT. IN NO EVENT SHALL **UNA-DYN** BE LIABLE TO BUYER OR ITS CUSTOMERS FOR LOSS OF USE, REVENUE OR PROFIT, OR FOR ANY OTHER INCIDENTAL OR CONSEQUENTIAL DAMAGES ARISING OUT OF OR RELATING TO THE TRANSACTIONS HEREIN.

2. **ALL CLAIMS** under the guarantee above must be made promptly in writing to **UNA-DYN**. Defective material must either be returned to **UNA-DYN**, freight prepaid, or made available for inspection at customer's location within thirty (30) days of written claim.

3. **RETURNS** - Before returning any material, **CUSTOMER** will request a Returned Goods Authorization (RGA) number from **UNA-DYN** and this number must be used to identify the returned material and all associated documents. **ALL RETURNED MATERIAL MUST BE SHIPPED PREPAID**.

4. Any replacement parts will be shipped freight collect. Shipment of replacements prior to receipt and inspection of presumed defective parts does not waive **UNA-DYN**'s rights.

The decision to repair, replace, or issue credit for defective material rests solely with **UNA-DYN**.

5. **PRICES** - All prices are F.O.B. dock, Woodbridge, Virginia, or point of manufacture. Prices do not include sales, use, excise, or similar taxes, which shall be paid by the **PURCHASER** or in lieu thereof, the **PURCHASER** shall provide **UNA-DYN** with a certificate of tax exemption acceptable to the taxing authorities.

6. **ORDERS** - To be binding and valid, all orders must be accepted in writing by the **COMPANY** either at its principal office in Woodbridge, Virginia or the office of the Material Handling Division. **UNA-DYN** reserves the right to refuse any order prior to its written acceptance. The **PURCHASER** will provide all necessary credit information to enable **UNA-DYN** to assess and approve their credit worthiness. A 30% deposit of all orders over \$10,000 (USD) is required. The remaining 70% is Net 30.

7. **DELIVERY** - Delivery dates refer to the dates when it is estimated that the equipment will be ready for shipment from the place of manufacture and are based on prompt receipt by the seller of the order and of information necessary to permit the seller to proceed with work immediately and without interruption. It is understood and agreed that shipping dates are approximate only and while **UNA-DYN** will use all reasonable diligence to meet them, it does not guarantee any shipping date.

8. **DELAYS** - If shipment is delayed at **PURCHASER'S** request, payments due upon and after shipment are due as though shipment has

been made at the time **CUSTOMER** was notified that shipment was ready.

If shipment is delayed more than seven (7) days at **CUSTOMER'S** request, material may be stored at **UNA-DYN's** premises or a public warehouse; and **CUSTOMER** agrees to pay all reasonable storage and removal charges related to such storage.

9. **ENGINEERING CHANGES** - **UNA-DYN** reserves the right to make changes in designs and/or construction in its products at any time without incurring any obligation on units previously delivered to modify such units to include subsequent changes.

10. **TERMINATION** - **PURCHASER** may terminate the contract of which these conditions are a part upon notice in writing to **UNA-DYN**. For standard products the **PURCHASER** shall pay twenty percent (20%) of the selling price of such equipment.

For special products not part of **UNA-DYN's** standard line, **UNA-DYN** shall cease work and deliver to **PURCHASER** all completed or partially completed equipment and work in process. **PURCHASER** shall pay **UNA-DYN** the contract price for all completed equipment, plus all expenses of **UNA-DYN** in connection with partially completed work including direct factory and engineering costs, cancellation charges to **UNA-DYN** on account of any commitments made under the contract, and an additional 10% of all charges to cover overhead.

11. **PURCHASER** - will use and shall require its employees to use all safety devices and guards on the shipment and maintain the same in proper working order. **PURCHASER** shall use and require its employees to use safe operating procedures in operating the equipment. If **PURCHASER** fails to observe the obligations in this paragraph, **PURCHASER** agrees to indemnify and save **UNA-DYN** harmless from any liability or obligation incurred by **UNA-DYN** to persons injured directly or indirectly in connection with the operation of the equipment. **PURCHASER** further agrees to notify **UNA-DYN** promptly, and in any event within thirty (30) days, of any accident or malfunction involving **UNA-DYN's** equipment which results in personal injury or damage to property and to cooperate fully with **UNA-DYN** in investigating and determining the causes of such accident or malfunction. In the event that **PURCHASER** fails to give such notice to **UNA-DYN** or to cooperate with **UNA-DYN**, **PURCHASER** agrees to indemnify and save **UNA-DYN** harmless from any claims arising from such accident or malfunction.

12. **GENERAL :**

A) This agreement is the final and complete agreement of the parties. There are no other agreements, contracts, understandings, or representations, oral or written, expressed or implied with respect to this transaction or the equipment being sold hereunder. No amendment thereto shall be effective unless in writing and signed by the parties.

B) In all cases clerical errors are subject to correction.

C) In the event that any terms of this agreement be or become or are declared to be invalid or void by any court of competent jurisdiction such terms shall be null and void, and shall be deemed deleted from this agreement, and all remaining terms of the agreement shall remain in full force and effect.

D) The validity, enforceability and interpretation of the above terms and conditions shall be determined and governed by the laws of the Commonwealth of Virginia.

13. **GOVERNING LAW AND FORUM** - The rights and obligations of the parties under this Agreement and any action in contract or tort between said parties under this agreement or resulting from the use or operation of equipment shall be governed by the laws of the Commonwealth of Virginia and may be brought only in the courts of the Commonwealth of Virginia

